



AXIOMTEK

PICO841/843

**Intel® Atom™ E3845/E3827
Intel® Celeron® J1900/N2807
Processors Pico-ITX Board**

User's Manual



Disclaimers

This manual has been carefully checked and believed to contain accurate information. Axiomtek Co., Ltd. assumes no responsibility for any infringements of patents or any third party's rights, and any liability arising from such use.

Axiomtek does not warrant or assume any legal liability or responsibility for the accuracy, completeness or usefulness of any information in this document. Axiomtek does not make any commitment to update the information in this manual.

Axiomtek reserves the right to change or revise this document and/or product at any time without notice.

No part of this document may be reproduced, stored in a retrieval system, or transmitted, in any form or by any means, electronic, mechanical, photocopying, recording, or otherwise, without the prior written permission of Axiomtek Co., Ltd.

CAUTION

If you replace wrong batteries, it causes the danger of explosion. It is recommended by the manufacturer that you follow the manufacturer's instructions to only replace the same or equivalent type of battery, and dispose of used ones.

©Copyright 2021 Axiomtek Co., Ltd.

All Rights Reserved

August 2021, Version A3

Printed in Taiwan

ESD Precautions

Computer boards have integrated circuits sensitive to static electricity. To prevent chipsets from electrostatic discharge damage, please take care of the following jobs with precautions:

- Do not remove boards or integrated circuits from their anti-static packaging until you are ready to install them.
- Before holding the board or integrated circuit, touch an unpainted portion of the system unit chassis for a few seconds. It discharges static electricity from your body.
- Wear a wrist-grounding strap, available from most electronic component stores, when handling boards and components.

Trademarks Acknowledgments

Axiomtek is a trademark of Axiomtek Co., Ltd.

Windows[®] is a trademark of Microsoft Corporation.

AMI is a trademark of American Megatrend Inc.

IBM, PC/AT, PS/2, VGA are trademarks of International Business Machines Corporation.

Intel[®] and Celeron[®] are trademarks of Intel Corporation.

Other brand names and trademarks are the properties and registered brands of their respective owners.

Table of Contents

Disclaimers.....	ii
ESD Precautions.....	iii
Chapter 1 Introduction.....	1
1.1 Features.....	2
1.2 Specifications.....	2
1.3 Utilities Supported.....	3
Chapter 2 Board and Pin Assignments.....	5
2.1 Board Dimensions and Fixing Holes.....	5
2.2 Board Layout.....	7
2.3 Assembly Drawing.....	9
2.4 Jumper Settings.....	12
2.4.1 LVDS Voltage Selection (JP1 and JP2).....	13
2.4.2 Auto Power On (JP4).....	13
2.4.3 LVDS Brightness Control Mode Setting (JP5).....	13
2.4.4 Restore BIOS Optimal Defaults (JP6).....	13
2.5 Connectors.....	14
2.5.1 Board to Board Connectors (CN1 and CN2).....	15
2.5.2 Fan Power Connector (CN3).....	16
2.5.3 SMBus Connector (CN4).....	16
2.5.4 Power LED Header (CN6).....	16
2.5.5 External Speaker and Internal Buzzer Header (CN7).....	16
2.5.6 LVDS Connector (CN8).....	17
2.5.7 SATA Power Connector (CN9).....	19
2.5.8 Inverter Connector (CN10).....	19
2.5.9 DC Power Connector (CN11).....	19
2.5.10 VGA Connector (CN12).....	20
2.5.11 Ethernet Connector (LAN1).....	20
2.5.12 SATA Connector (SATA1).....	21
2.5.13 CMOS Battery Connector (BAT1).....	21
2.5.14 Full-size PCI-Express Mini Card and mSATA Connector (SCN1).....	22
2.5.15 SIM Card Slot (SCN2).....	23
2.5.16 Half-size PCI-Express Mini Card Connector (SCN3).....	23
Chapter 3 AX93283 I/O Board.....	25
3.1 AX93283 Specifications.....	25
3.2 AX93283 Dimensions and Fixing Holes.....	25

3.3	AX93283 Board Layout	26
3.4	AX93283 Jumper Settings	27
3.4.1	COM1 Data/Power Selection (JP1 and JP2)	27
3.5	AX93283 Connectors, Switches and LED	28
3.5.1	System Reset Switch (CN1).....	28
3.5.2	Audio Jack (CN2)	28
3.5.3	COM1 Connector (CN3).....	29
3.5.4	COM2 Connector (CN4).....	29
3.5.5	System Power Switch (CN5).....	29
3.5.6	Board to Board Connectors (CN9 and CN10).....	30
3.5.7	USB Connectors (USB1 and USB2)	31
3.5.8	Power and HDD LED Indicator (D1)	31
Chapter 4	AX93267 I/O Board	33
4.1	AX93267 Specifications	33
4.2	AX93267 Dimensions and Fixing Holes	34
4.3	AX93267 Board Layout	35
4.4	AX93267 Connectors	36
4.4.1	DC Power Jack (CN1).....	36
4.4.2	DC Power Connector (CN2).....	36
4.4.3	VGA Connector (CN3).....	37
4.4.4	D-Sub VGA Connector (CN4)	37
4.4.5	Ethernet Connector (CN5)	38
4.4.6	RJ-45 Ethernet Port (CN6).....	38
Chapter 5	Hardware Description	39
5.1	Microprocessors	39
5.2	BIOS	39
5.3	System Memory.....	39
5.4	I/O Port Address Map.....	40
5.5	Interrupt Controller (IRQ) Map	41
5.6	Memory Map	43
Chapter 6	AMI BIOS Setup Utility.....	45
6.1	Starting.....	45
6.2	Navigation Keys	45
6.3	Main Menu.....	46
6.4	Advanced Menu.....	47
6.5	Chipset Menu.....	61
6.6	Security Menu.....	65

6.7	Boot Menu.....	66
6.8	Save & Exit Menu	67
Appendix A Watchdog Timer		69
A.1	About Watchdog Timer	69
A.2	How to Use Watchdog Timer.....	69
A.3	Sample Program.....	70
Appendix B Window® 7 Installation Guide		73
Appendix C BIOS Flash Utility.....		75

Chapter 1

Introduction

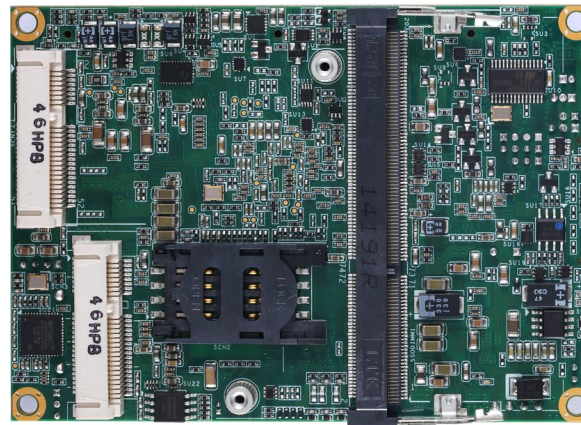
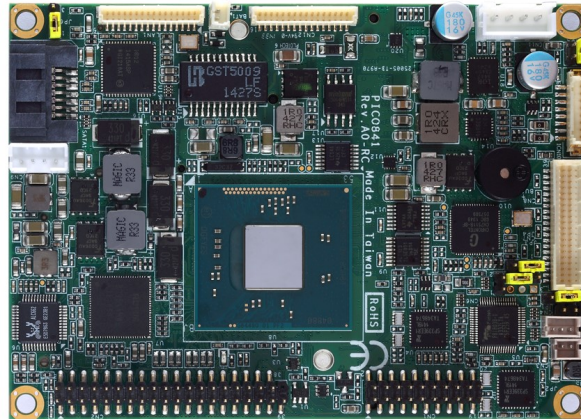

The PICO841 is a Pico-ITX board with Intel® Atom™ E3845/E3827 processors. Meanwhile PICO843, a Pico-ITX board, supports Intel® Celeron® J1900/N2807 processors. Both of them deliver outstanding system performance through high-bandwidth interfaces, multiple I/O functions for interactive applications and various embedded computing solutions.

The PICO841/843 have one 204-pin unbuffered SO-DIMM socket for DDR3L 1333/1066MHz memory, with maximum memory capacity up to 8GB. It also features one Gigabit/Fast Ethernet, one SATA port with transfer rates up to 3Gb/s, four USB 2.0 high speed compliant, and built-in high definition audio codec that can achieve the best stability and reliability for industrial applications. Moreover, it has one full-size PCI-Express Mini Card and one half-size PCI-Express Mini Card which provide good expansions for network connecting. Additionally, it provides you with unique embedded features, such as two serial ports (RS-232/422/485) and Pico-ITX form factor that applies an extensive array of PC peripherals. The board can be enhanced by its built-in watchdog timer function, a special industrial feature not commonly seen on other motherboards.

1.1 Features

- PICO841 - Intel® Atom™ quad core E3845 (1.91GHz), and dual core E3827 (1.75GHz)
- PICO843 - Intel® Celeron® quad core J1900 (2GHz) and dual core N2807 (1.58GHz)
- 1 DDR3L SO-DIMM supports up to 8GB memory capacity
- 4 USB 2.0 ports
- 2 COM ports
- 1 full-size PCI-Express Mini Card
- 1 half-size PCI-Express Mini Card
- +12V only DC-in supported

1.2 Specifications

- **CPU**
 - PICO841
 - Intel® Atom™ quad core E3845 1.91GHz.
 - Intel® Atom™ dual core E3827 1.75GHz.
 - PICO843
 - Intel® Celeron® quad core J1900 2GHz.
 - Intel® Celeron® dual core N2807 1.58GHz.
- **Thermal Solution**
 - Fanless but with reserved fan connector.
- **Operating Temperature**
 - -20°C~70°C.
- **BIOS**
 - American Megatrends Inc. UEFI (Unified Extensible Firmware Interface) BIOS.
 - 16Mbit SPI Flash, DMI, Plug and Play.
 - PXE Ethernet Boot ROM.
- **System Memory**
 - One 204-pin unbuffered DDR3L SO-DIMM socket.
 - Maximum up to 8GB DDR3L 1333/1066MHz memory.
- **Onboard Multi I/O**
 - Controller: Fintek F81803U
 - Serial Ports: Two ports for RS-232/422/485.
- **Serial ATA**
 - One SATA-300 connector.
 - mSATA supported.
- **Expansion**
 - One full-size PCI-Express Mini Card socket complies with PCI-Express Mini Card Spec. V1.2.
 - One half-size PCI-Express Mini Card socket complies with PCI-Express Mini Card Spec. V1.2.
- **USB Interface**
 - Four USB ports with fuse protection and comply with USB Spec. Rev. 2.0 in pin headers.

- **Display**
 - One 16-pin VGA wafer connector.
 - One 2x20-pin connector for 18-bit/24-bit dual channel LVDS and one 8-pin wafer connector for inverter control. LVDS resolution is up to 1920x1200 in 24-bit dual channels.

- **Trusted Platform Module (TPM)**
 - Controller: ST ST33TPM12LPC via LPC bus interface.
 - Complies with TPM1.2 main and PC client specification.

- **Watchdog Timer**
 - 1~255 seconds or minutes; up to 255 levels.

- **Ethernet**
 - One 16-pin wafer connector.
 - One port with Intel® i211AT supporting 1000/100/10Mbps Gigabit/Fast Ethernet with Wake-on-LAN and PXE Boot ROM.

- **Audio**
 - HD audio compliant with Realtek ALC888S.
 - MIC-in and line-out in pin headers.

- **Power Input**
 - One 1x4-pin wafer connector.
 - +12V only DC-in.
 - AT auto power on function supported.

- **Power Management**
 - ACPI (Advanced Configuration and Power Interface).

- **Form Factor**
 - Pico-ITX form factor.



Note

All specifications and images are subject to change without notice.

1.3 Utilities Supported

- Chipset and graphics driver
- Ethernet driver
- Audio driver
- XHCI driver
- Trusted Execution Engine
- Sideband Fabric Device

This page is intentionally left blank.

Chapter 2

Board and Pin Assignments

2.1 Board Dimensions and Fixing Holes

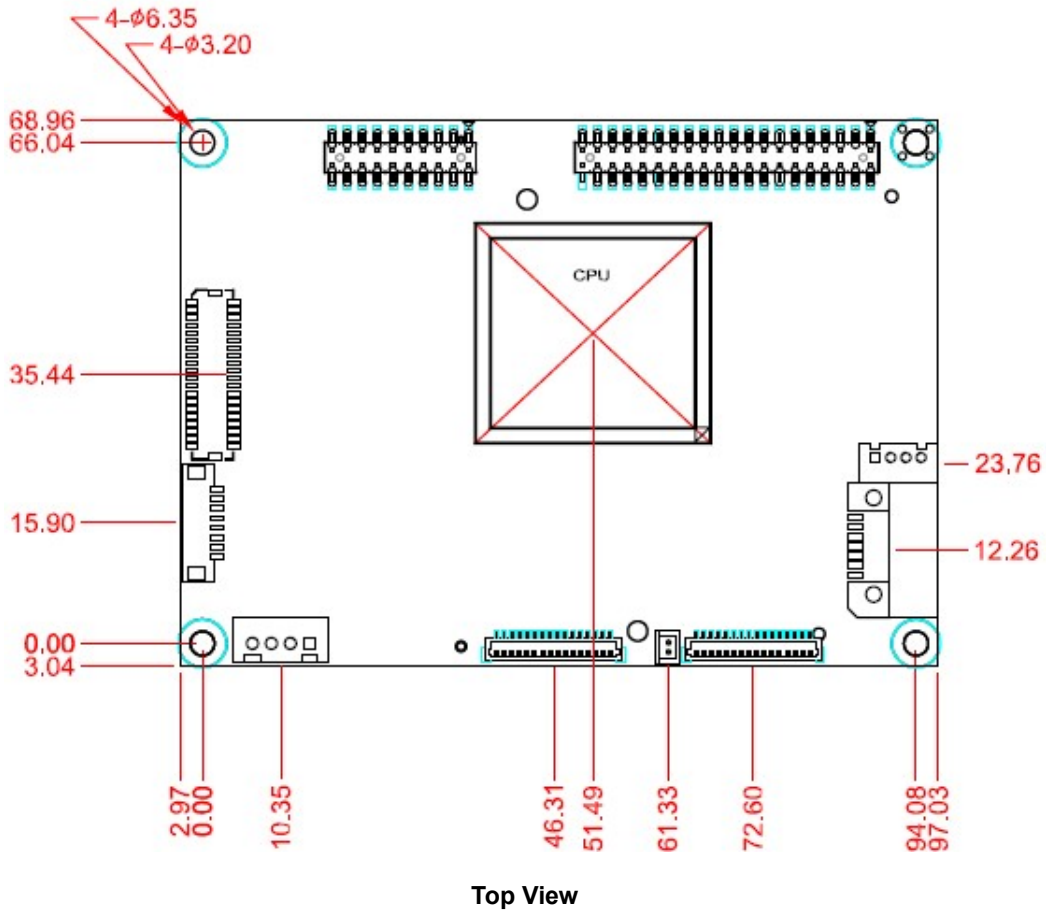

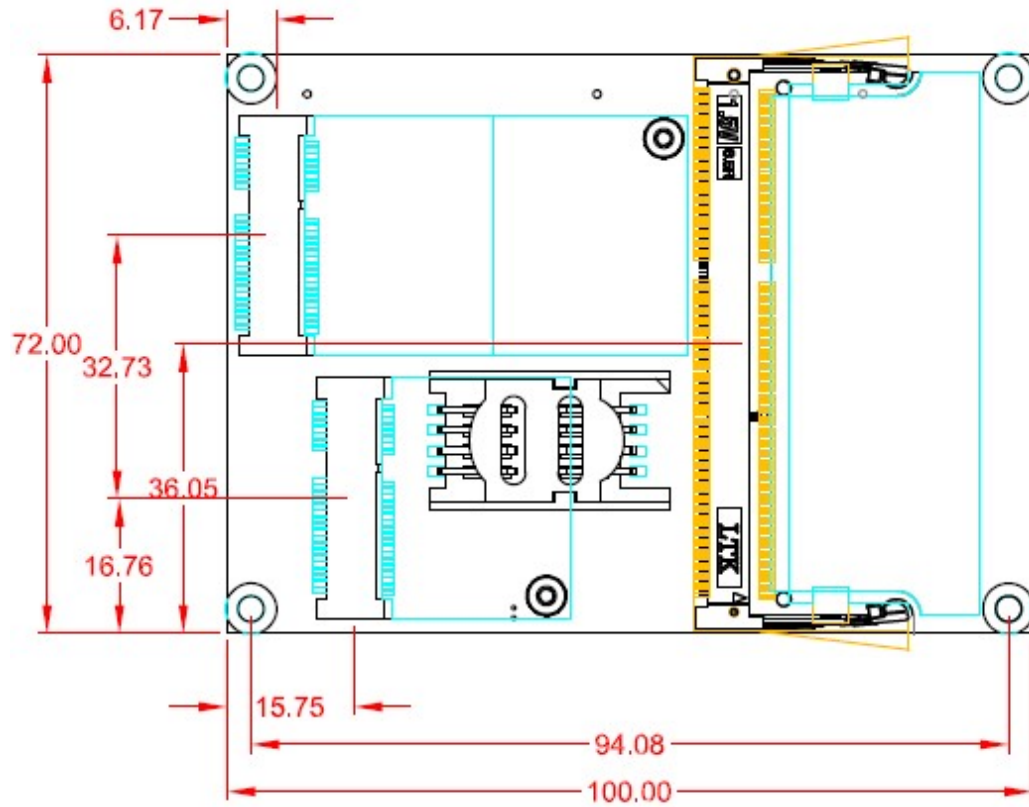

Bottom View

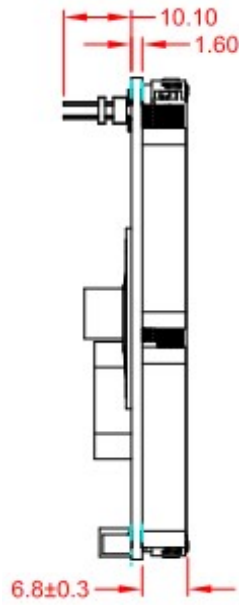

Side View

2.2 Board Layout

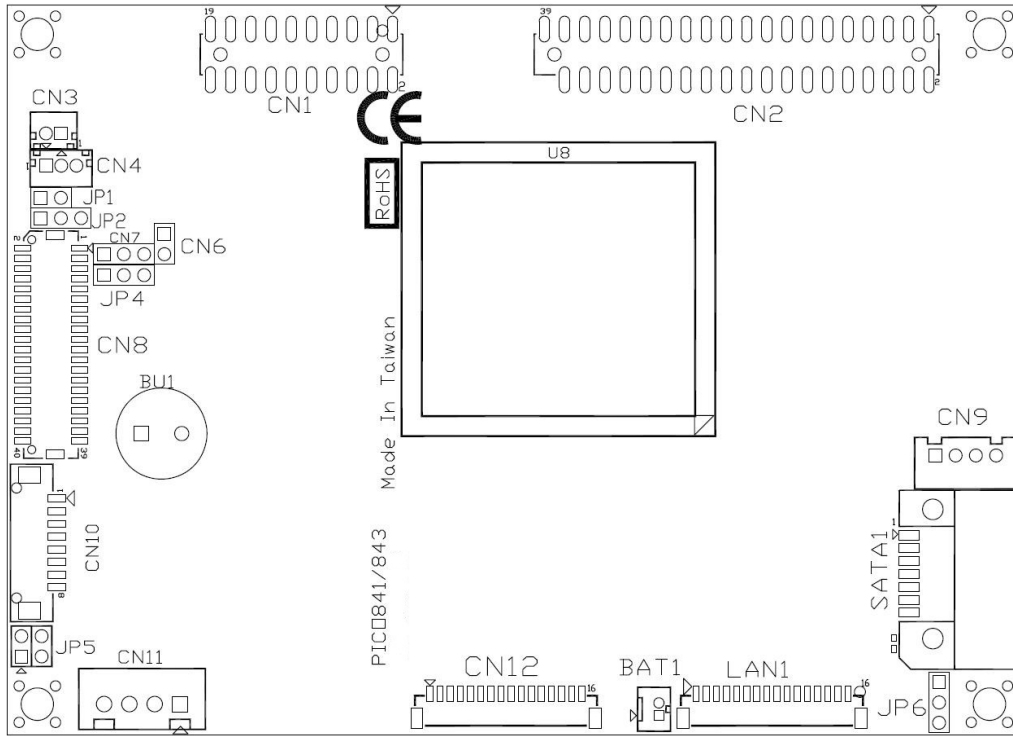

Top View

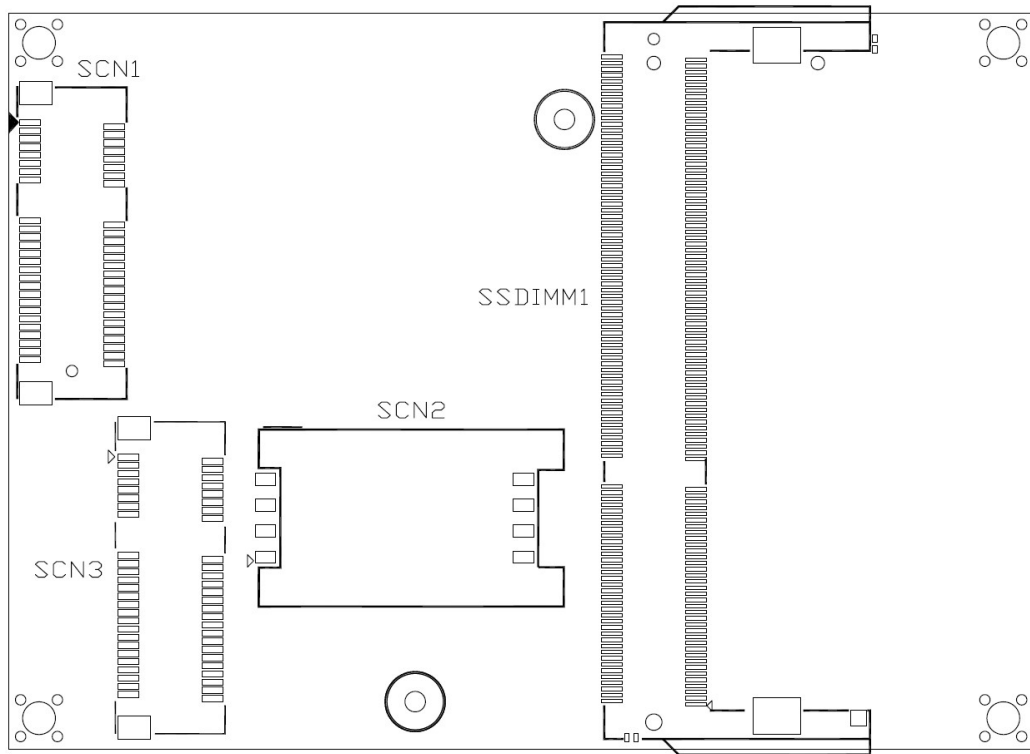

Bottom View

2.3 Assembly Drawing

Heatsink for PICO841/843 (see image below):

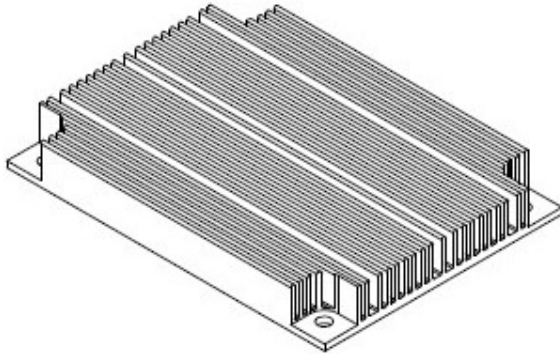

First of all, use the following four screws to secure heatsink on heatspreader.

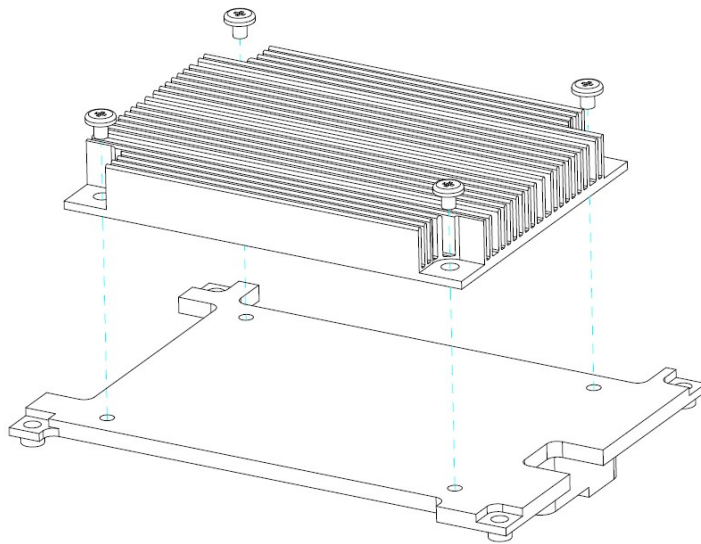

x4

For thermal dissipation, a heatspreader enables the PICO841/843's components to dissipate heat efficiently. Images below illustrate how to install the heatspreader.

Installing Heatspreader

The PICO841/843 has four assembly holes for installing heatspreader plate. Align and firmly secure the heatspreader plate to the PICO841/843. Be careful not to over-tighten the screws.

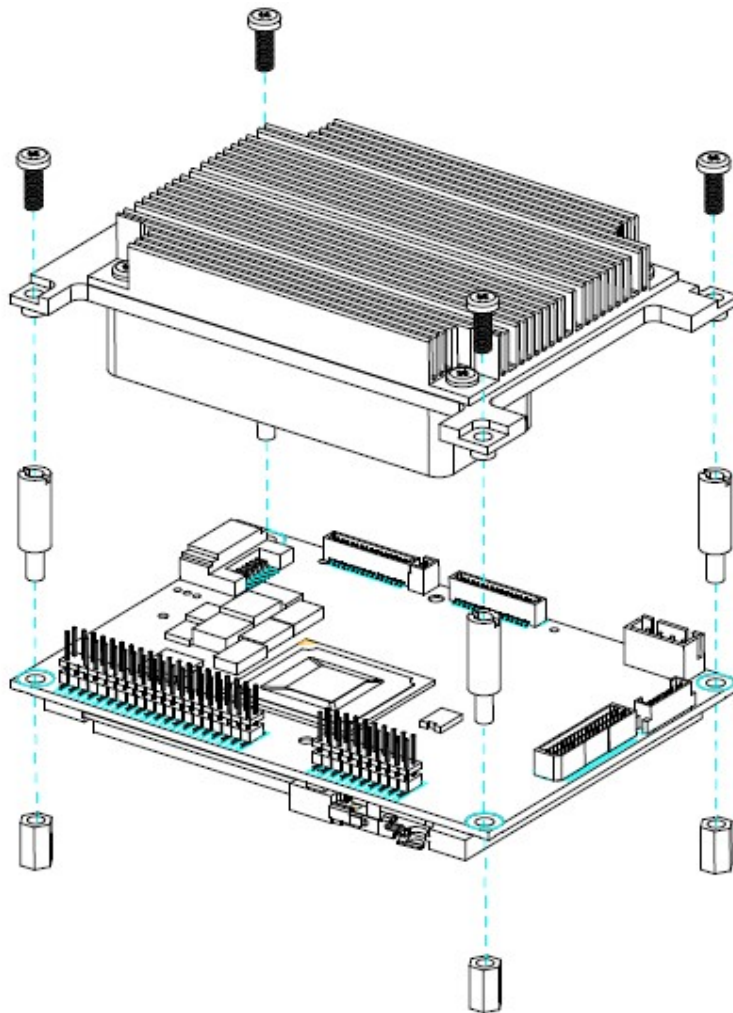

Installing Heatspreader and I/O Board

Gently insert I/O board into CN1 and CN2. Align and use the four screws to firmly secure the heatspreader plate and I/O board to the PICO841/843. Be careful not to over-tighten the screws. See chapter 3 and chapter 4 for more details of AX93283 and AX93267 I/O boards.

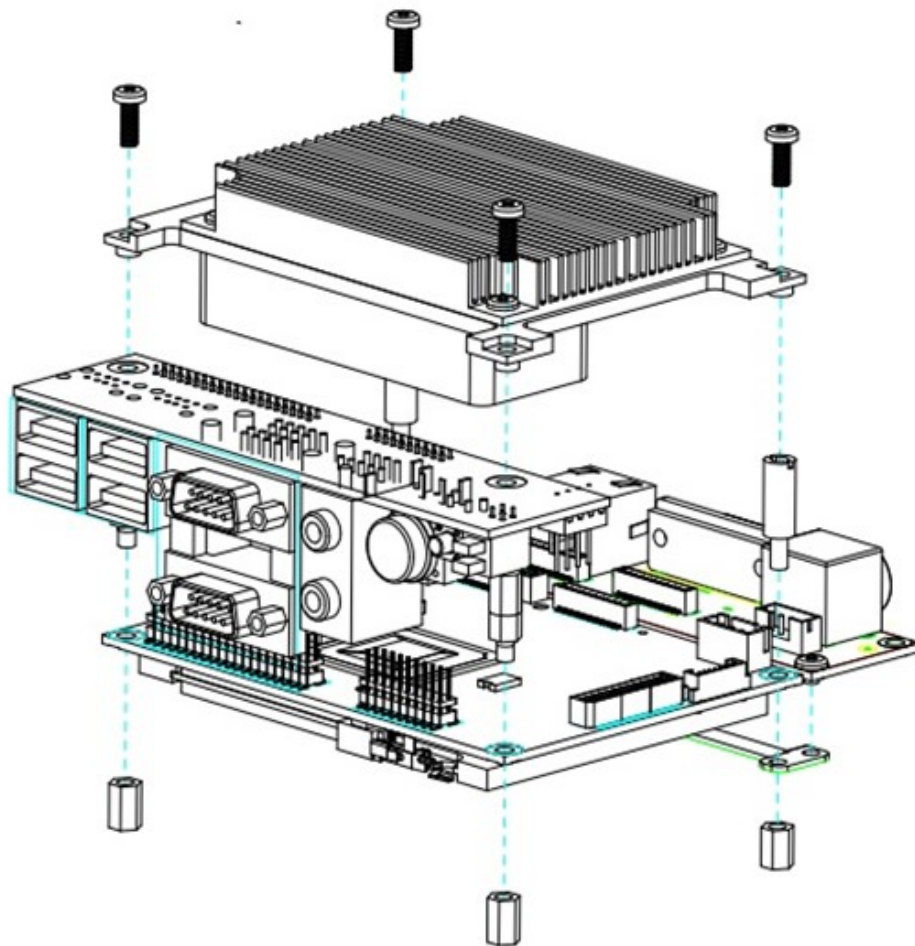
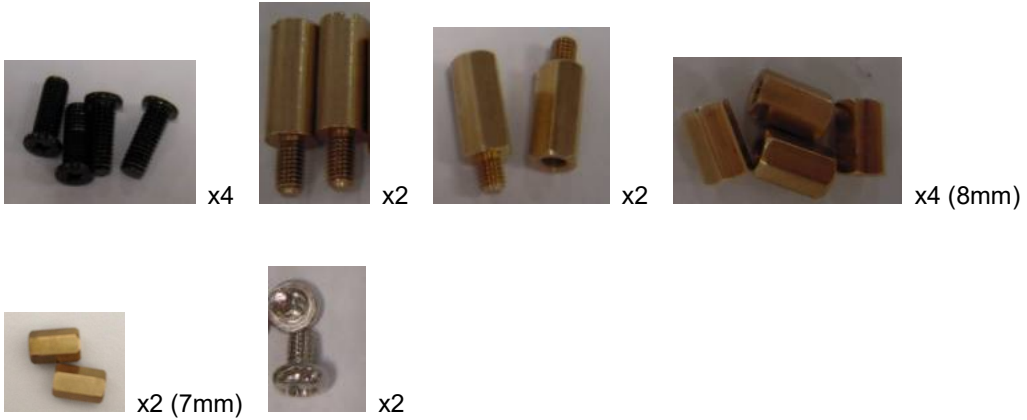

2.4 Jumper Settings

Jumper is a small component consisting of jumper clip and jumper pins. Install jumper clip on 2 jumper pins to close. And remove jumper clip from 2 jumper pins to open. Below illustration shows how to set up jumper.

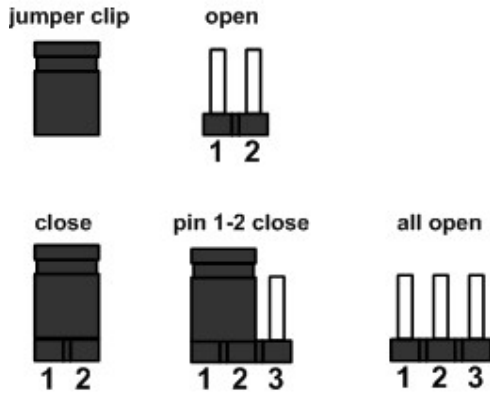

Properly configure jumper settings on the PICO841/843 to meet your application purpose. Below you can find a summary table of all jumpers and onboard default settings.



Note

Once the default jumper needs to be changed, please do it under power-off condition.

Jumper	Description	Setting
JP1	LVDS +12V Voltage Selection Default: None	None
JP2	LVDS +3.3V/+5V Voltage Selection Default: +3.3V	1-2 Close
JP4	Auto Power On Default: Disable	1-2 Close
JP5	LVDS Brightness Control Mode Setting Default: PWM Mode	1-2 Close
JP6	Restore BIOS Optimal Defaults Default: Normal Operation	1-2 Close

2.4.1 LVDS Voltage Selection (JP1 and JP2)

The board supports voltage selection for flat panel displays. Use these jumpers to set LVDS connector (CN8) pin 1~6 VCCM to +3.3V, +5V or +12V. To prevent hardware damage, before connecting please make sure that input voltage of flat panel is correct.

Function	JP1 Setting
+12V level	Close
N/A	Open

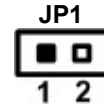

Function	JP2 Setting
+3.3V level (Default)	1-2 close
+5V level	2-3 close

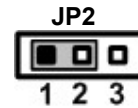

2.4.2 Auto Power On (JP4)

If this jumper is enabled for power input, the system will be automatically power on without pressing soft power button. If this jumper is disabled for power input, it is necessary to manually press soft power button to power on the system.

Function	Setting
Disable auto power on (Default)	1-2 close
Enable auto power on	2-3 close



2.4.3 LVDS Brightness Control Mode Setting (JP5)

This jumper enables you to select PWM or voltage control mode for inverter connector (CN10). These two control modes are for adjusting the brightness of LVDS panel.

Function	Setting
PWM mode (Default)	1-2 close
Voltage mode	3-4 close

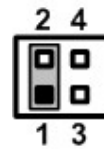

2.4.4 Restore BIOS Optimal Defaults (JP6)

Put jumper clip to pin 2-3 for a few seconds then move it back to pin 1-2. Doing this procedure can restore BIOS optimal defaults.

Function	Setting
Normal (Default)	1-2 close
Restore BIOS optimal defaults	2-3 close

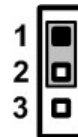

2.5 Connectors

Signals go to other parts of the system through connectors. Loose or improper connection might cause problems, please make sure all connectors are properly and firmly connected. Here is a summary table which shows all connectors on the hardware.

Connector	Description
CN1	20-pin Board to Board Connector
CN2	40-pin Board to Board Connector
CN3	Fan Power Connector
CN4	SMBus Connector
CN6	Power LED Header
CN7	External Speaker and Internal Buzzer Header
CN8	LVDS Connector
CN9	SATA Power Connector
CN10	Inverter Connector
CN11	DC Power Connector
CN12	VGA Connector
LAN1	Ethernet Port
SATA1	SATA Connector
BAT1	CMOS Battery Connector
SCN1	Full-size PCI-Express Mini Card and mSATA Connector
SCN2	SIM Card Slot
SCN3	Half-size PCI-Express Mini Card Connector
SSODIMM1	DDR3L SO-DIMM Socket

2.5.1 Board to Board Connectors (CN1 and CN2)

The pin assignments of CN1 are given as follows.

Pin	Signal	Pin	Signal
1	DCD2	2	DSR2
3	RXD2	4	RTS2
5	TXD2	6	CTS2
7	DTR2	8	RI2
9	GND	10	+5V
11	DCD1	12	DSR1
13	RXD1	14	RTS1
15	TXD1	16	CTS1
17	DTR1	18	RI1
19	GND	20	+5V

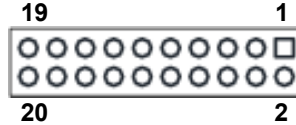

The pin assignments of CN2 are given as follows.

Pin	Signal	Pin	Signal
1	MIC	2	LINE_OUT_L
3	LINE_IN_L	4	LINE_OUT_R
5	LINE_IN_R	6	GND
7	GND	8	GND
9	GND	10	GND
11	USB1_PWR	12	USB1_PWR
13	USB0_DATA-	14	USB1_DATA-
15	USB0_DATA+	16	USB1_DATA+
17	GND	18	GND
19	GND	20	GND
21	USB2_PWR	22	USB2_PWR
23	USB2_DATA-	24	USB3_DATA-
25	USB2_DATA+	26	USB3_DATA+
27	GND	28	GND
29	GND	30	GND
31	+5V	32	PS_ON
33	RESET	34	GND
35	+5V	36	+12V
37	HDD_LED	38	+12V
39	GND	40	Ni

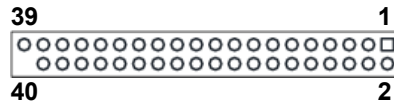

Note

During Windows® 7 installation, the HSIC USB (USB port 2 and 3) can not be used. Device driver must be installed in advance in order for the HSIC USB to work properly in Windows® 7.



Note

It is suggested to insert AX93283 I/O board into CN1 and CN2 (see chapter 3 for details of AX93283).

2.5.2 Fan Power Connector (CN3)

This is a JST B2B-ZH-K-S 1.5mm pitch wafer connector for fan power interface.

Pin	Signal
1	+5V
2	GND

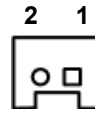

2.5.3 SMBus Connector (CN4)

This connector is for SMBus interface. The SMBus (System Management Bus) is a simple 2-wire bus for the purpose of lightweight communication.

Pin	Signal
1	SMBus clock
2	SMBus data
3	GND

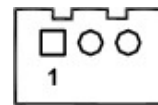

2.5.4 Power LED Header (CN6)

This header is for power LED interface.

Pin	Signal
1	+5V
2	GND



2.5.5 External Speaker and Internal Buzzer Header (CN7)

Pin 1, 2 and 3 connect the case-mounted speaker unit or internal buzzer. While connecting the CPU board to an internal buzzer, please set pin 2 and 3 closed (default); while connecting to an external speaker, you need to set pins 2 and 3 opened and connect the speaker cable to pin 1(+) and pin 2(-).

Pin	Signal
1	EXT SPK+
2	EXT SPK-
3	Buzzer



2.5.6 LVDS Connector (CN8)

This board has a 2x20-pin connector for LVDS LCD interface. It is strongly recommended to use the matching JST SHDR-40VS-B connector for LVDS interface. Pin 1~6 VCCM can be set to +3.3V, +5V or +12V by setting JP2 or JP1 (see section 2.4.1).

18-bit single channel

Pin	Signal	Pin	Signal
1	VCCM	2	VCCM
3	VCCM	4	VCCM
5	VCCM	6	VCCM
7	N.C	8	N.C
9	GND	10	GND
11	N.C	12	N.C
13	N.C	14	N.C
15	GND	16	GND
17	N.C	18	N.C
19	N.C	20	N.C
21	GND	22	GND
23	Channel A D0-	24	N.C
25	Channel A D0+	26	N.C
27	GND	28	GND
29	Channel A D1-	30	N.C
31	Channel A D1+	32	N.C
33	GND	34	GND
35	Channel A D2-	36	Channel A CLK-
37	Channel A D2+	38	Channel A CLK+
39	GND	40	GND

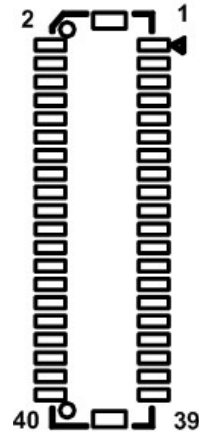

24-bit single channel

Pin	Signal	Pin	Signal
1	VCCM	2	VCCM
3	VCCM	4	VCCM
5	VCCM	6	VCCM
7	N.C	8	N.C
9	GND	10	GND
11	N.C	12	N.C
13	N.C	14	N.C
15	GND	16	GND
17	N.C	18	N.C
19	N.C	20	N.C
21	GND	22	GND
23	Channel A D0-	24	N.C
25	Channel A D0+	26	N.C
27	GND	28	GND
29	Channel A D1-	30	Channel A D3-
31	Channel A D1+	32	Channel A D3+
33	GND	34	GND
35	Channel A D2-	36	Channel A CLK-
37	Channel A D2+	38	Channel A CLK+
39	GND	40	GND

18-bit dual channel

Pin	Signal	Pin	Signal
1	VCCM	2	VCCM
3	VCCM	4	VCCM
5	VCCM	6	VCCM
7	N.C	8	N.C
9	GND	10	GND
11	N.C	12	Channel B D0-
13	N.C	14	Channel B D0+
15	GND	16	GND
17	Channel B CLK-	18	Channel B D1-
19	Channel B CLK+	20	Channel B D1+
21	GND	22	GND
23	Channel A D0-	24	Channel B D2-
25	Channel A D0+	26	Channel B D2+
27	GND	28	GND
29	Channel A D1-	30	N.C
31	Channel A D1+	32	N.C
33	GND	34	GND
35	Channel A D2-	36	Channel A CLK-
37	Channel A D2+	38	Channel A CLK+
39	GND	40	GND

24-bit dual channel

Pin	Signal	Pin	Signal
1	VCCM	2	VCCM
3	VCCM	4	VCCM
5	VCCM	6	VCCM
7	N.C	8	N.C
9	GND	10	GND
11	Channel B D3-	12	Channel B D0-
13	Channel B D3+	14	Channel B D0+
15	GND	16	GND
17	Channel B CLK-	18	Channel B D1-
19	Channel B CLK+	20	Channel B D1+
21	GND	22	GND
23	Channel A D0-	24	Channel B D2-
25	Channel A D0+	26	Channel B D2+
27	GND	28	GND
29	Channel A D1-	30	Channel A D3-
31	Channel A D1+	32	Channel A D3+
33	GND	34	GND
35	Channel A D2-	36	Channel A CLK-
37	Channel A D2+	38	Channel A CLK+
39	GND	40	GND

2.5.7 SATA Power Connector (CN9)

The CN9 is JST B4B-PH-K-S 4-pin 2.0mm pitch wafer connector for SATA power interface.

Pin	Signal
1	+12V
2	GND
3	GND
4	+5V

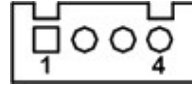

2.5.8 Inverter Connector (CN10)

This is a Hirose DF13-8S-1.25C 8-pin connector for inverter. We strongly recommend you to use the matching DF13-8S-1.25C connector to avoid malfunction.

Pin	Signal
1	VBL1 (+12V level)
2	VBL1 (+12V level)
3	VBL2 (+5V level)
4	VBL_ENABLE
5	GND
6	GND
7	GND
8	VBL Brightness Control



2.5.9 DC Power Connector (CN11)

This is a JST B4B-XH 4-pin 2.5mm pitch wafer connector for DC +12V input. It is suggested to connect this CN11 to AX93267 I/O board's CN2.

Pin	Signal
1	+12V
2	+12V
3	GND
4	GND

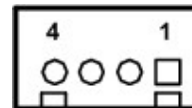

2.5.10 VGA Connector (CN12)

This is a JST BM16B-SRSS-TB 16-pin wafer connector for VGA interface. Gently connect this CN12 to AX93267 I/O board's CN3.

Pin	Signal
1	RSVD
2	RED
3	GND
4	GREEN
5	GND
6	BLUE
7	GND
8	VCC
9	DDC_DATA
10	GND
11	GND
12	HSYNC
13	GND
14	VSYNC
15	DDC_CLK
16	GND

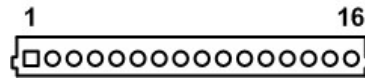

2.5.11 Ethernet Connector (LAN1)

This is a JST BM16B-SRSS-TB 16-pin wafer connector for Ethernet interface. Gently connect this LAN1 to AX93267 I/O board's CN5.

Pin	Signal
1	1000 LAN LED
2	100 LAN LED
3	GND
4	MDI3-
5	MDI3+
6	MDI1-
7	MDI2-
8	MDI2+
9	MDI1+
10	MDI0-
11	MDI0+
12	GND
13	LAN_VDD33
14	LAN_LINK_ACT
15	GND
16	GND

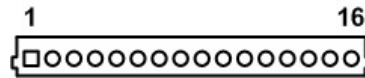

2.5.12 SATA Connector (SATA1)

This Serial Advanced Technology Attachment (Serial ATA or SATA) connector is for high-speed SATA interface. It is a computer bus interface for connecting to devices such as hard disk drives.

Pin	Signal
1	GND
2	TXP
3	TXN
4	GND
5	RXN
6	RXP
7	GND

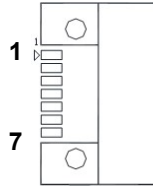

2.5.13 CMOS Battery Connector (BAT1)

This connector is for CMOS battery interface.

Pin	Signal
1	+3.3V
2	GND



2.5.14 Full-size PCI-Express Mini Card and mSATA Connector (SCN1)

This is a full-size PCI-Express Mini Card connector on the bottom side complying with PCI-Express Mini Card Spec. V1.2. It supports either PCI-Express, USB 2.0 or SATA (mSATA). Since the default setting is mSATA, if the PCI-Express Mini Card is needed to insert, please refer to section 6.4 to change the setting.

Pin	Signal	Pin	Signal
1	WAKE#	2	+3.3V_SBY
3	No use	4	GND
5	No use	6	+V1.5S
7	CLKREQ#	8	SIM PWR
9	GND	10	SIM I/O
11	CLK_PICE_N	12	SIM CLK
13	CLK_PICE_P	14	SIM RST
15	GND	16	SIM VPP
17	No use	18	GND
19	No use	20	+3.3V_SBY
21	GND	22	PLTRST
23	mSATA_RXP /PCIE_RXN	24	+3.3V_SBY
25	mSATA_RXN /PCIE_RXP	26	GND
27	GND	28	+V1.5S
29	GND	30	SMB_CLK
31	mSATA_TXN /PCIE_TXN	32	SMB_DATA
33	mSATA_TXP /PCIE_TXP	34	GND
35	GND	36	USB_PN2
37	GND	38	USB_PP2
39	+3.3V_SBY	40	GND
41	+3.3V_SBY	42	No use
43	GND	44	No use
45	No use	46	No use
47	No use	48	+V1.5S
49	No use	50	GND
51	No use	52	+3.3V_SBY

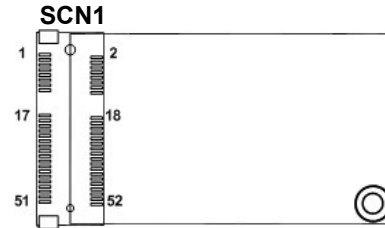

2.5.15 SIM Card Slot (SCN2)

The SCN2 on the bottom side is for inserting SIM Card. It is mainly used in 3G wireless network application. In order to work properly, the SIM Card must be used together with Mini Card which is inserted to SCN1 or SCN3.

Pin	Signal
1	SIM PWR
2	SIM RST
3	SIM CLK
4	NC
5	GND
6	SIM VPP
7	SIM I/O
8	NC



2.5.16 Half-size PCI-Express Mini Card Connector (SCN3)

This is a half-size PCI-Express Mini Card connector on the bottom side complying with PCI-Express Mini Card Spec. V1.2. It supports either PCI-Express or USB 2.0.

Pin	Signal	Pin	Signal
1	WAKE#	2	+3.3V_SBY
3	No use	4	GND
5	No use	6	+V1.5S
7	CLKREQ#	8	SIM PWR
9	GND	10	SIM I/O
11	CLK_PICE_N	12	SIM CLK
13	CLK_PICE_P	14	SIM RST
15	GND	16	SIM VPP
17	No use	18	GND
19	No use	20	+3.3V_SBY
21	GND	22	PLTRST
23	PCIE_RXN1	24	+3.3V_SBY
25	PCIE_RXP1	26	GND
27	GND	28	+V1.5S
29	GND	30	SMB_CLK
31	PCIE_TXN1	32	SMB_DATA
33	PCIE_TXP1	34	GND
35	GND	36	USB_PN3
37	GND	38	USB_PP3
39	+3.3V_SBY	40	GND
41	+3.3V_SBY	42	No use
43	GND	44	No use
45	No use	46	No use
47	No use	48	+V1.5S
49	No use	50	GND
51	No use	52	+3.3V_SBY

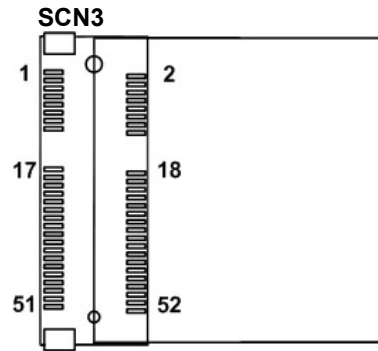

This page is intentionally left blank.

Chapter 3

AX93283 I/O Board

The AX93283 is an I/O expansion board which is suggested to insert carefully into CN1 and CN2 of PICO841/843. Its specifications and detailed information are given in this chapter.

3.1 AX93283 Specifications

- **Size**
 - 29.25mm x 118mm
- **Features**
 - Supports audio jack (MIC-in/line-out).
 - Four USB 2.0.
 - Serial ports: Two ports for RS-232/422/485.
 - Power-on, reset and red/green LED.



All specifications and images are subject to change without notice.

Note

3.2 AX93283 Dimensions and Fixing Holes

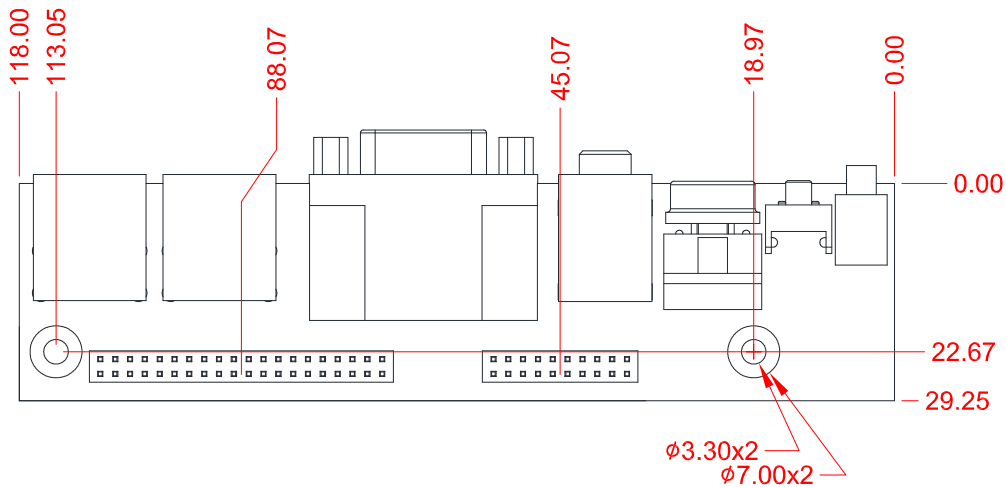

Top View

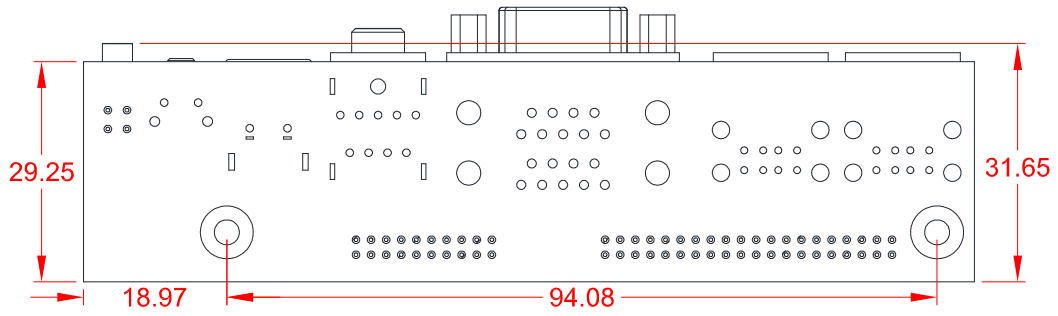

Bottom View

3.3 AX93283 Board Layout

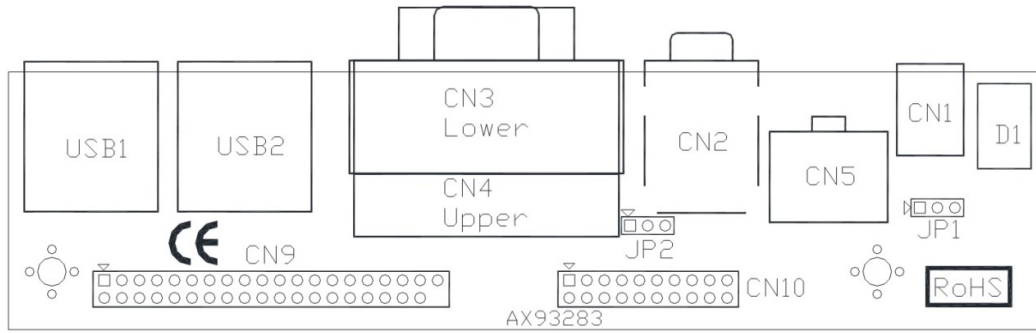

Top View

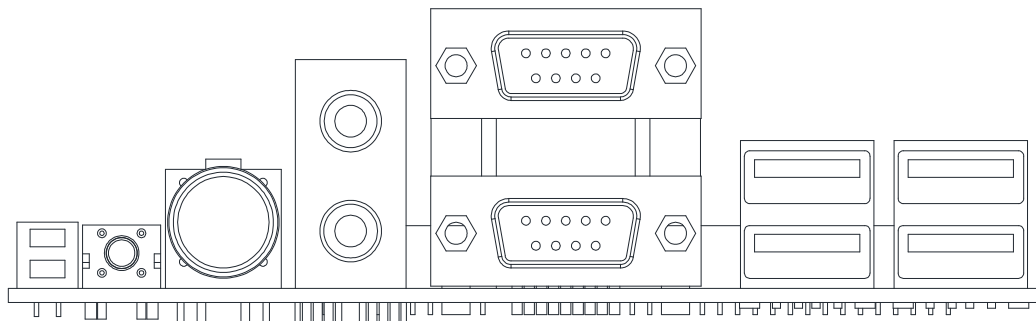

Side View

3.4 AX93283 Jumper Settings

Properly configure jumper settings on the AX93283 I/O board to meet your application purpose. Below you can find a summary table of all jumpers and onboard default settings.



Note

Once the default jumper setting needs to be changed, please do it under power-off condition.

Jumper	Description	Setting
JP1	COM1 Data/+12V Power Selection Default: RS-232 Data	CN3 Pin 18: RI 1-2 Close
JP2	COM1 Data/+5V Power Selection Default: RS-232 Data	CN3 Pin 10: DCD 1-2 Close

3.4.1 COM1 Data/Power Selection (JP1 and JP2)

The COM1 port has +12V level power capability on RI and +5V level on DCD by setting JP1 and JP2, respectively. When this port is set to +12V or +5V level, please make sure its communication mode is RS-232 (see section 6.4).

Function	JP1 Setting
Data: Set CN3 pin 18 to RI (Default)	1-2 close
Power: Set CN3 pin 18 to +12V level	2-3 close

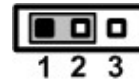

Function	JP2 Setting
Data: Set CN3 pin 10 to DCD (Default)	1-2 close
Power: Set CN3 pin 10 to +5V level	2-3 close



3.5 AX93283 Connectors, Switches and LED

Signals go to other parts of the system through connectors. Loose or improper connection might cause problems, please make sure all connectors are properly and firmly connected. Here is a summary table which shows all connectors, switches and LED on the hardware.

Connector/Switch/LED	Description
CN1	System Reset Switch
CN2	Audio Jack
CN3	COM1 Connector
CN4	COM2 Connector
CN5	System Power Switch
CN9	40-pin Board to Board Connector
CN10	20-pin Board to Board Connector
USB1~USB2	USB 2.0 Connectors
D1	Power and HDD LED indicator

3.5.1 System Reset Switch (CN1)

This switch reboots your computer without turning off the power supply. It is a better way to reboot your system for a longer life of the system power supply.

Function	Description
On	Reset system
Off	Keep system status



3.5.2 Audio Jack (CN2)

This is audio jack with HD audio support. Install audio driver, and then attach audio devices to CN2.

Pin Color	Signal
Green	Line-out
Pink	MIC-in



3.5.3 COM1 Connector (CN3)

CN3 is the lower connector of the double-deck DB-9 connector. Only COM1 comes with power capability on DCD and RI pins by setting jumpers (see section 3.4.1). The pin assignments of RS-232/422/485 are listed in table below. If you need COM1 port to support RS-422 or RS-485, please refer to section 6.4.

Pin	RS-232	RS-422	RS-485
10	DCD	TX-	Data-
11	RXD	TX+	Data+
12	TXD	RX+	N.C
13	DTR	RX-	N.C.
14	GND	No use	No use
15	DSR	No use	No use
16	RTS	No use	No use
17	CTS	No use	No use
18	RI	No use	No use

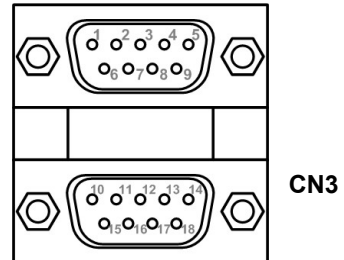

3.5.4 COM2 Connector (CN4)

CN4 is the upper connector of the double-deck DB-9 connector. The pin assignments of RS-232/422/485 are listed in table below. If you need COM2 port to support RS-422 or RS-485, please refer to section 6.4.

Pin	RS-232	RS-422	RS-485
1	DCD	TX-	Data-
2	RXD	TX+	Data+
3	TXD	RX+	N.C
4	DTR	RX-	N.C.
5	GND	No use	No use
6	DSR	No use	No use
7	RTS	No use	No use
8	CTS	No use	No use
9	RI	No use	No use

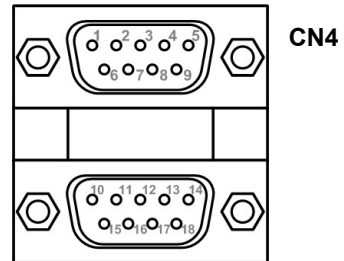

3.5.5 System Power Switch (CN5)

This switch is for turning on/off the system power.

Function	Description
On	Turn on/off system
Off	Keep system status

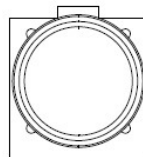

3.5.6 Board to Board Connectors (CN9 and CN10)

The pin assignments of CN9 are given as follows.

Pin	Signal	Pin	Signal
1	MIC	2	LINE_OUT_L
3	LINE_IN_L	4	LINE_OUT_R
5	LINE_IN_R	6	GND
7	GND	8	GND
9	GND	10	GND
11	USB1_PWR	12	USB1_PWR
13	USB0_DATA-	14	USB1_DATA-
15	USB0_DATA+	16	USB1_DATA+
17	GND	18	GND
19	GND	20	GND
21	USB2_PWR	22	USB2_PWR
23	USB2_DATA-	24	USB3_DATA-
25	USB2_DATA+	26	USB3_DATA+
27	GND	28	GND
29	GND	30	GND
31	+5V	32	PS_ON
33	RESET	34	GND
35	+5V	36	+12V
37	HDD_LED	38	+12V
39	GND	40	Ni

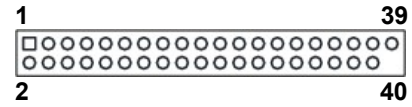

The pin assignments of CN10 are given as follows.

Pin	Signal	Pin	Signal
1	DCD2	2	DSR2
3	RXD2	4	RTS2
5	TXD2	6	CTS2
7	DTR2	8	RI2
9	GND	10	+5V
11	DCD1	12	DSR1
13	RXD1	14	RTS1
15	TXD1	16	CTS1
17	DTR1	18	RI1
19	GND	20	+5V

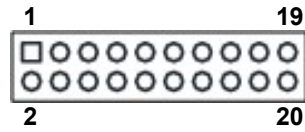

Note

Please gently insert CN9 and CN10 into CN2 and CN1 of PICO841/843.

3.5.7 USB Connectors (USB1 and USB2)

The board comes with two double-deck Universal Serial Bus (compliant with USB 2.0 (480Mbps)) connectors on the rear I/O which are for installing USB peripherals such as keyboard, mouse, scanner, etc.

Pin	Signal	Pin	Signal
1	+5V	5	+5V
2	USB1/3_DATA-	6	USB2/4_DATA-
3	USB1/3_DATA+	7	USB2/4_DATA+
4	GND	8	GND

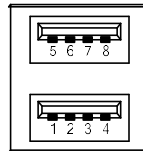

3.5.8 Power and HDD LED Indicator (D1)

The red LED is linked to Hard Disk Drive (HDD) activity signal. LED flashes every time HDD is accessed.

The power LED (green) lights up and will remain steady while the system is powered on.

LED Color	Description
Red	Hard disk drive activity
Green	Power on/off



This page is intentionally left blank.

Chapter 4

AX93267 I/O Board

The AX93267 is an I/O expansion board which is suggested to insert carefully into CN1 and CN2 of PICO841/843. Its specifications and detailed information are given in this chapter.

4.1 AX93267 Specifications

- **Size**
 - 29.25mm x 118mm

- **Features**
 - One D-Sub VGA port
 - One RJ-45 Ethernet port.
 - DC power jack.



Note

All specifications and images are subject to change without notice.

4.2 AX93267 Dimensions and Fixing Holes

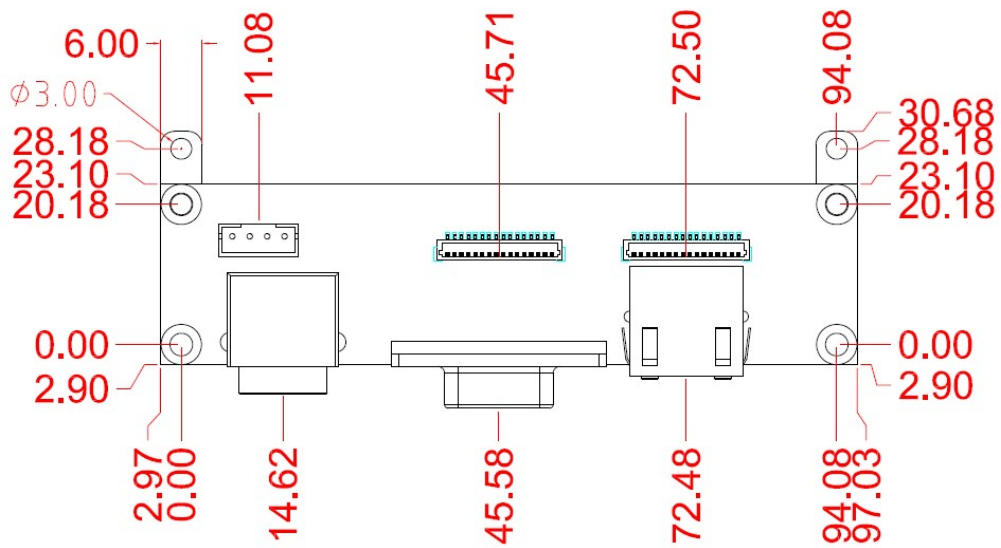

Top View

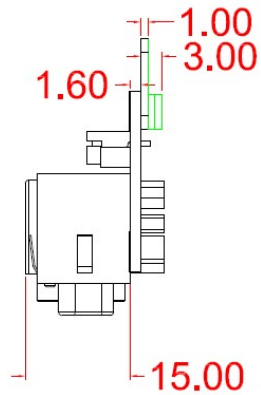

Side View

4.3 AX93267 Board Layout

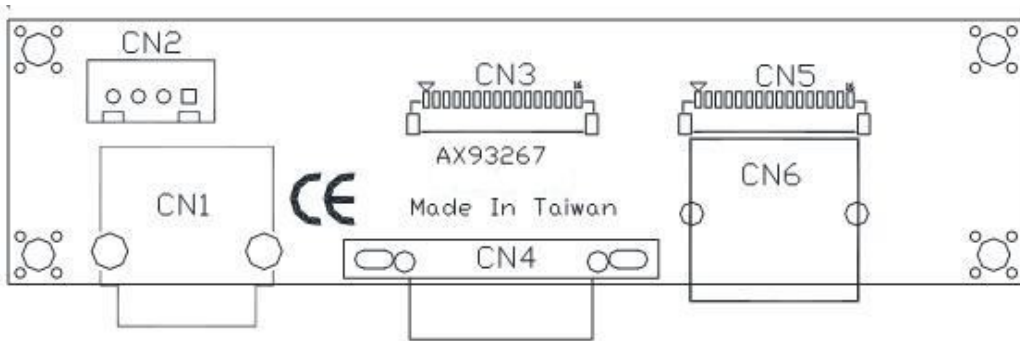

Top View

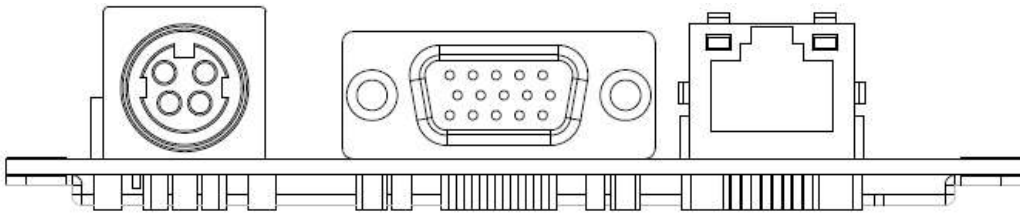

Side View

4.4 AX93267 Connectors

Signals go to other parts of the system through connectors. Loose or improper connection might cause problems, please make sure all connectors are properly and firmly connected. Here is a summary table which shows all connectors on the hardware.

Connector	Description
CN1	DC Power Jack
CN2	DC Power Connector
CN3	VGA Connector
CN4	D-Sub VGA Connector
CN5	Ethernet Connector
CN6	RJ-45 Ethernet Port

4.4.1 DC Power Jack (CN1)

The CN1 is a DC power jack for DC +12V input.

Pin	Signal
1	GND
2	GND
3	+12V
4	+12V

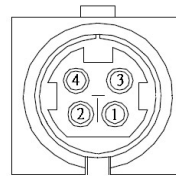

4.4.2 DC Power Connector (CN2)

This is a 1x4-pin wafer connector for DC +12V. It is suggested to connect the CN2 to PICO841/843's CN11.

Pin	Signal
1	+12V
2	+12V
3	GND
4	GND

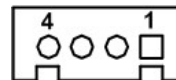

4.4.3 VGA Connector (CN3)

This is a 16-pin wafer connector for VGA interface. Gently connect this CN3 to PICO841/843's CN12.

Pin	Signal
1	RSVD
2	RED
3	GND
4	GREEN
5	GND
6	BLUE
7	GND
8	VCC
9	DDC_DATA
10	GND
11	GND
12	HSYNC
13	GND
14	VSYNC
15	DDC_CLK
16	GND

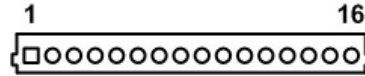

4.4.4 D-Sub VGA Connector (CN4)

The CN4 is a standard 15-pin D-Sub connector. It is commonly used for VGA display. This VGA interface configuration can be configured via software utility.

Pin	Signal	Pin	Signal
1	RED	2	GREEN
3	BLUE	4	N.C
5	GND	6	CRT_DETE
7	GND	8	GND
9	CRT_VCC	10	GND
11	N.C	12	DDC_DATA
13	HSYNC	14	VSYNC
15	DDC_CLK		

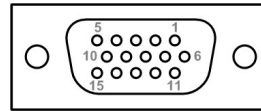

4.4.5 Ethernet Connector (CN5)

This is a 16-pin wafer connector for Ethernet interface. Gently connect this CN5 to PICO841/843's LAN1.

Pin	Signal
1	1000 LAN LED
2	100 LAN LED
3	GND
4	MDI3-
5	MDI3+
6	MDI1-
7	MDI2-
8	MDI2+
9	MDI1+
10	MDI0-
11	MDI0+
12	GND
13	LAN_VDD33
14	LAN_LINK_ACT
15	GND
16	GND

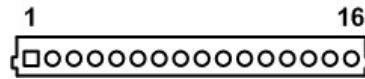

4.4.6 RJ-45 Ethernet Port (CN6)

This board has one RJ-45 Ethernet connector. Connection can be established by plugging one end of the Ethernet cable into this RJ-45 connector and the other end (phone jack) to a 1000/100/10-Base-T hub.

Pin	Signal	Pin	Signal
L1	MDI0P	L5	MDI2P
L2	MDI0N	L6	MDI2N
L3	MDI1P	L7	MDI3P
L4	MDI1N	L8	MDI3N
A	Active LED (Yellow)		
B	1000 LAN LED (Orange) / 100 LAN LED (Green)		

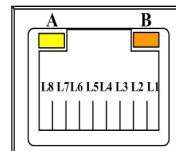

Chapter 5

Hardware Description

5.1 Microprocessors

The PICO841 supports Intel® Atom™ E3845/E3827 processors and PICO843 supports Intel® Celeron® J1900/N2807 processors, which enable your system to operate under Windows® 7 environments. The system performance depends on the microprocessor. Make sure all correct settings are arranged for your installed microprocessor to prevent the CPU from damages.

5.2 BIOS

The PICO841/843 uses AMI Plug and Play BIOS with a single 16Mbit SPI Flash.

5.3 System Memory

The PICO841/843 supports one 204-pin DDR3L SO-DIMM socket for maximum memory capacity up to 8GB DDR3L SDRAMs. The memory module comes in sizes of 1GB, 2GB, 4GB and 8GB.































































5.4 I/O Port Address Map

Address Range	Device Name
[0000000000000000 - 000000000000006F]	PCI bus
[0000000000000020 - 0000000000000021]	Programmable interrupt controller
[0000000000000024 - 0000000000000025]	Programmable interrupt controller
[0000000000000028 - 0000000000000029]	Programmable interrupt controller
[000000000000002C - 000000000000002D]	Programmable interrupt controller
[000000000000002E - 000000000000002F]	Motherboard resources
[0000000000000030 - 0000000000000031]	Programmable interrupt controller
[0000000000000034 - 0000000000000035]	Programmable interrupt controller
[0000000000000038 - 0000000000000039]	Programmable interrupt controller
[000000000000003C - 000000000000003D]	Programmable interrupt controller
[0000000000000040 - 0000000000000043]	System timer
[000000000000004E - 000000000000004F]	Motherboard resources
[0000000000000050 - 0000000000000053]	System timer
[0000000000000061 - 0000000000000061]	Motherboard resources
[0000000000000063 - 0000000000000063]	Motherboard resources
[0000000000000065 - 0000000000000065]	Motherboard resources
[0000000000000067 - 0000000000000067]	Motherboard resources
[0000000000000070 - 0000000000000070]	Motherboard resources
[0000000000000070 - 0000000000000077]	System CMOS/real time clock
[0000000000000078 - 00000000000000CF]	PCI bus
[0000000000000080 - 000000000000008F]	Motherboard resources
[0000000000000092 - 0000000000000092]	Motherboard resources
[00000000000000A0 - 00000000000000A1]	Programmable interrupt controller
[00000000000000A4 - 00000000000000A5]	Programmable interrupt controller
[00000000000000A8 - 00000000000000A9]	Programmable interrupt controller
[00000000000000AC - 00000000000000AD]	Programmable interrupt controller
[00000000000000B0 - 00000000000000B1]	Programmable interrupt controller
[00000000000000B2 - 00000000000000B3]	Motherboard resources
[00000000000000B4 - 00000000000000B5]	Programmable interrupt controller
[00000000000000B8 - 00000000000000B9]	Programmable interrupt controller
[00000000000000BC - 00000000000000BD]	Programmable interrupt controller
[00000000000002F8 - 00000000000002FF]	Communications Port (COM2)
[00000000000003B0 - 00000000000003BB]	Intel(R) Atom(TM) Processor E3800 Series/Intel(R) Celeron(R) Processor N2920/J1900
[00000000000003C0 - 00000000000003DF]	Intel(R) Atom(TM) Processor E3800 Series/Intel(R) Celeron(R) Processor N2920/J1900
[00000000000003F8 - 00000000000003FF]	Communications Port (COM1)
[0000000000000400 - 000000000000047F]	Motherboard resources
[00000000000004D0 - 00000000000004D1]	Programmable interrupt controller
[0000000000000500 - 00000000000005FE]	Motherboard resources
[0000000000000600 - 000000000000061F]	Motherboard resources
[0000000000000680 - 000000000000069F]	Motherboard resources
[0000000000000A00 - 0000000000000A0F]	Motherboard resources
[0000000000000A10 - 0000000000000A1F]	Motherboard resources
[0000000000000A20 - 0000000000000A2F]	Motherboard resources
[0000000000000D00 - 0000000000000FFF]	PCI bus
[0000000000000D00 - 0000000000000DFF]	Intel(R) Atom(TM)/Celeron(R)/Pentium(R) Processor PCI Express - Root Port 1 - 0F48
[0000000000000E00 - 0000000000000E01F]	Intel(R) Atom(TM)/Celeron(R)/Pentium(R) Processor Platform Control Unit - SMBus Port - 0F12
[0000000000000E20 - 0000000000000E03F]	Intel(R) Atom(TM)/Celeron(R)/Pentium(R) Processor AHCI - 0F23
[0000000000000E40 - 0000000000000E043]	Intel(R) Atom(TM)/Celeron(R)/Pentium(R) Processor AHCI - 0F23
[0000000000000E50 - 0000000000000E057]	Intel(R) Atom(TM)/Celeron(R)/Pentium(R) Processor AHCI - 0F23
[0000000000000E60 - 0000000000000E063]	Intel(R) Atom(TM)/Celeron(R)/Pentium(R) Processor AHCI - 0F23
[0000000000000E70 - 0000000000000E077]	Intel(R) Atom(TM)/Celeron(R)/Pentium(R) Processor AHCI - 0F23
[0000000000000E80 - 0000000000000E087]	Intel(R) Atom(TM) Processor E3800 Series/Intel(R) Celeron(R) Processor N2920/J1900

5.5 Interrupt Controller (IRQ) Map

The interrupt controller (IRQ) mapping list is shown as follows:

Interrupt request (IRQ)	Description
(ISA) 0x00000000 (00)	System timer
(ISA) 0x00000003 (03)	Communications Port (COM2)
(ISA) 0x00000004 (04)	Communications Port (COM1)
(ISA) 0x00000008 (08)	High precision event timer
(ISA) 0x00000051 (81)	Microsoft ACPI-Compliant System
(ISA) 0x00000052 (82)	Microsoft ACPI-Compliant System
(ISA) 0x00000053 (83)	Microsoft ACPI-Compliant System
(ISA) 0x00000054 (84)	Microsoft ACPI-Compliant System
(ISA) 0x00000055 (85)	Microsoft ACPI-Compliant System
(ISA) 0x00000056 (86)	Microsoft ACPI-Compliant System
(ISA) 0x00000057 (87)	Microsoft ACPI-Compliant System
(ISA) 0x00000058 (88)	Microsoft ACPI-Compliant System
(ISA) 0x00000059 (89)	Microsoft ACPI-Compliant System
(ISA) 0x0000005A (90)	Microsoft ACPI-Compliant System
(ISA) 0x0000005B (91)	Microsoft ACPI-Compliant System
(ISA) 0x0000005C (92)	Microsoft ACPI-Compliant System
(ISA) 0x0000005D (93)	Microsoft ACPI-Compliant System
(ISA) 0x0000005E (94)	Microsoft ACPI-Compliant System
(ISA) 0x0000005F (95)	Microsoft ACPI-Compliant System
(ISA) 0x00000060 (96)	Microsoft ACPI-Compliant System
(ISA) 0x00000061 (97)	Microsoft ACPI-Compliant System
(ISA) 0x00000062 (98)	Microsoft ACPI-Compliant System
(ISA) 0x00000063 (99)	Microsoft ACPI-Compliant System
(ISA) 0x00000064 (100)	Microsoft ACPI-Compliant System
(ISA) 0x00000065 (101)	Microsoft ACPI-Compliant System
(ISA) 0x00000066 (102)	Microsoft ACPI-Compliant System
(ISA) 0x00000067 (103)	Microsoft ACPI-Compliant System
(ISA) 0x00000068 (104)	Microsoft ACPI-Compliant System
(ISA) 0x00000069 (105)	Microsoft ACPI-Compliant System
(ISA) 0x0000006A (106)	Microsoft ACPI-Compliant System
(ISA) 0x0000006B (107)	Microsoft ACPI-Compliant System
(ISA) 0x0000006C (108)	Microsoft ACPI-Compliant System
(ISA) 0x0000006D (109)	Microsoft ACPI-Compliant System
(ISA) 0x0000006E (110)	Microsoft ACPI-Compliant System
(ISA) 0x0000006F (111)	Microsoft ACPI-Compliant System
(ISA) 0x00000070 (112)	Microsoft ACPI-Compliant System
(ISA) 0x00000071 (113)	Microsoft ACPI-Compliant System
(ISA) 0x00000072 (114)	Microsoft ACPI-Compliant System
(ISA) 0x00000073 (115)	Microsoft ACPI-Compliant System
(ISA) 0x00000074 (116)	Microsoft ACPI-Compliant System
(ISA) 0x00000075 (117)	Microsoft ACPI-Compliant System
(ISA) 0x00000076 (118)	Microsoft ACPI-Compliant System
(ISA) 0x00000077 (119)	Microsoft ACPI-Compliant System
(ISA) 0x00000078 (120)	Microsoft ACPI-Compliant System
(ISA) 0x00000079 (121)	Microsoft ACPI-Compliant System
(ISA) 0x0000007A (122)	Microsoft ACPI-Compliant System
(ISA) 0x0000007B (123)	Microsoft ACPI-Compliant System
(ISA) 0x0000007C (124)	Microsoft ACPI-Compliant System
(ISA) 0x0000007D (125)	Microsoft ACPI-Compliant System
(ISA) 0x0000007E (126)	Microsoft ACPI-Compliant System
(ISA) 0x0000007F (127)	Microsoft ACPI-Compliant System
(ISA) 0x00000080 (128)	Microsoft ACPI-Compliant System
(ISA) 0x00000081 (129)	Microsoft ACPI-Compliant System
(ISA) 0x00000082 (130)	Microsoft ACPI-Compliant System
(ISA) 0x00000083 (131)	Microsoft ACPI-Compliant System
(ISA) 0x00000084 (132)	Microsoft ACPI-Compliant System
(ISA) 0x00000085 (133)	Microsoft ACPI-Compliant System
(ISA) 0x00000086 (134)	Microsoft ACPI-Compliant System
(ISA) 0x00000087 (135)	Microsoft ACPI-Compliant System
(ISA) 0x00000088 (136)	Microsoft ACPI-Compliant System
(ISA) 0x00000089 (137)	Microsoft ACPI-Compliant System
(ISA) 0x0000008A (138)	Microsoft ACPI-Compliant System
(ISA) 0x0000008B (139)	Microsoft ACPI-Compliant System
(ISA) 0x0000008C (140)	Microsoft ACPI-Compliant System
(ISA) 0x0000008D (141)	Microsoft ACPI-Compliant System
(ISA) 0x0000008E (142)	Microsoft ACPI-Compliant System
(ISA) 0x0000008F (143)	Microsoft ACPI-Compliant System
(ISA) 0x00000090 (144)	Microsoft ACPI-Compliant System
(ISA) 0x00000091 (145)	Microsoft ACPI-Compliant System

	(ISA) 0x00000091 (145)	Microsoft ACPI-Compliant System
	(ISA) 0x00000092 (146)	Microsoft ACPI-Compliant System
	(ISA) 0x00000093 (147)	Microsoft ACPI-Compliant System
	(ISA) 0x00000094 (148)	Microsoft ACPI-Compliant System
	(ISA) 0x00000095 (149)	Microsoft ACPI-Compliant System
	(ISA) 0x00000096 (150)	Microsoft ACPI-Compliant System
	(ISA) 0x00000097 (151)	Microsoft ACPI-Compliant System
	(ISA) 0x00000098 (152)	Microsoft ACPI-Compliant System
	(ISA) 0x00000099 (153)	Microsoft ACPI-Compliant System
	(ISA) 0x0000009A (154)	Microsoft ACPI-Compliant System
	(ISA) 0x0000009B (155)	Microsoft ACPI-Compliant System
	(ISA) 0x0000009C (156)	Microsoft ACPI-Compliant System
	(ISA) 0x0000009D (157)	Microsoft ACPI-Compliant System
	(ISA) 0x0000009E (158)	Microsoft ACPI-Compliant System
	(ISA) 0x0000009F (159)	Microsoft ACPI-Compliant System
	(ISA) 0x000000A0 (160)	Microsoft ACPI-Compliant System
	(ISA) 0x000000A1 (161)	Microsoft ACPI-Compliant System
	(ISA) 0x000000A2 (162)	Microsoft ACPI-Compliant System
	(ISA) 0x000000A3 (163)	Microsoft ACPI-Compliant System
	(ISA) 0x000000A4 (164)	Microsoft ACPI-Compliant System
	(ISA) 0x000000A5 (165)	Microsoft ACPI-Compliant System
	(ISA) 0x000000A6 (166)	Microsoft ACPI-Compliant System
	(ISA) 0x000000A7 (167)	Microsoft ACPI-Compliant System
	(ISA) 0x000000A8 (168)	Microsoft ACPI-Compliant System
	(ISA) 0x000000A9 (169)	Microsoft ACPI-Compliant System
	(ISA) 0x000000AA (170)	Microsoft ACPI-Compliant System
	(ISA) 0x000000AB (171)	Microsoft ACPI-Compliant System
	(ISA) 0x000000AC (172)	Microsoft ACPI-Compliant System
	(ISA) 0x000000AD (173)	Microsoft ACPI-Compliant System
	(ISA) 0x000000AE (174)	Microsoft ACPI-Compliant System
	(ISA) 0x000000AF (175)	Microsoft ACPI-Compliant System
	(ISA) 0x000000B0 (176)	Microsoft ACPI-Compliant System
	(ISA) 0x000000B1 (177)	Microsoft ACPI-Compliant System
	(ISA) 0x000000B2 (178)	Microsoft ACPI-Compliant System
	(ISA) 0x000000B3 (179)	Microsoft ACPI-Compliant System
	(ISA) 0x000000B4 (180)	Microsoft ACPI-Compliant System
	(ISA) 0x000000B5 (181)	Microsoft ACPI-Compliant System
	(ISA) 0x000000B6 (182)	Microsoft ACPI-Compliant System
	(ISA) 0x000000B7 (183)	Microsoft ACPI-Compliant System
	(ISA) 0x000000B8 (184)	Microsoft ACPI-Compliant System
	(ISA) 0x000000B9 (185)	Microsoft ACPI-Compliant System
	(ISA) 0x000000BA (186)	Microsoft ACPI-Compliant System
	(ISA) 0x000000BB (187)	Microsoft ACPI-Compliant System
	(ISA) 0x000000BC (188)	Microsoft ACPI-Compliant System
	(ISA) 0x000000BD (189)	Microsoft ACPI-Compliant System
	(ISA) 0x000000BE (190)	Microsoft ACPI-Compliant System
	(PCI) 0x0000000B (11)	Intel(R) Atom(TM)/Celeron(R)/Pentium(R) Processor Trusted Execution Engine Interface - 0F18
	(PCI) 0x00000008 (11)	Intel(R) Atom(TM)/Celeron(R)/Pentium(R) Processor Platform Control Unit - SMBus Port - 0F12
	(PCI) 0x00000010 (16)	Intel(R) Atom(TM)/Celeron(R)/Pentium(R) Processor PCI Express - Root Port 1 - 0F48
	(PCI) 0x00000011 (17)	Intel(R) Atom(TM)/Celeron(R)/Pentium(R) Processor PCI Express - Root Port 2 - 0F4A
	(PCI) 0x00000012 (18)	Intel(R) Atom(TM)/Celeron(R)/Pentium(R) Processor PCI Express - Root Port 3 - 0F4C
	(PCI) 0x00000013 (19)	Intel(R) Atom(TM)/Celeron(R)/Pentium(R) Processor AHCI - 0F23
	(PCI) 0x00000013 (19)	Intel(R) Atom(TM)/Celeron(R)/Pentium(R) Processor PCI Express - Root Port 4 - 0F4E
	(PCI) 0x00000016 (22)	High Definition Audio Controller
	(PCI) 0xFFFFFFFF (-9)	Intel(R) I211 Gigabit Network Connection
	(PCI) 0xFFFFFFFF (-8)	Intel(R) I211 Gigabit Network Connection
	(PCI) 0xFFFFFFFF (-7)	Intel(R) I211 Gigabit Network Connection
	(PCI) 0xFFFFFFFF (-6)	Intel(R) I211 Gigabit Network Connection
	(PCI) 0xFFFFFFFF (-5)	Intel(R) I211 Gigabit Network Connection
	(PCI) 0xFFFFFFFF (-4)	Intel(R) I211 Gigabit Network Connection
	(PCI) 0xFFFFFFFF (-3)	Intel(R) USB 3.0 eXtensible Host Controller
	(PCI) 0xFFFFFFFF (-2)	Intel(R) Atom(TM) Processor E3800 Series/Intel(R) Celeron(R) Processor N2920/J1900

5.6 Memory Map

The memory mapping list is shown as follows:

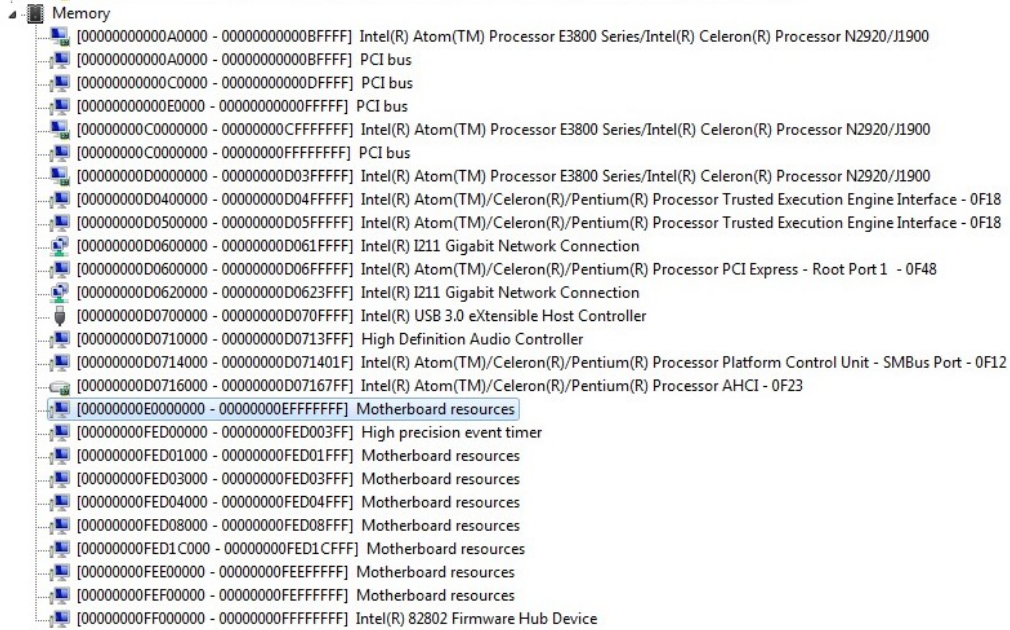

This page is intentionally left blank.

Chapter 6

AMI BIOS Setup Utility

The AMI UEFI BIOS provides users with a built-in setup program to modify basic system configuration. All configured parameters are stored in a flash chip to save the setup information whenever the power is turned off. This chapter provides users with detailed description about how to set up basic system configuration through the AMI BIOS setup utility.

6.1 Starting

To enter the setup screens, follow the steps below:

1. Turn on the computer and press the key immediately.
2. After you press the key, the main BIOS setup menu displays. You can access the other setup screens from the main BIOS setup menu, such as the Advanced and Chipset menus.



Note

If your computer cannot boot after making and saving system changes with BIOS setup, you can restore BIOS optimal defaults by setting JP6 (see section 2.4.4).

It is strongly recommended that you should avoid changing the chipset's defaults. Both AMI and your system manufacturer have carefully set up these defaults that provide the best performance and reliability.

6.2 Navigation Keys

The BIOS setup/utility uses a key-based navigation system called hot keys. Most of the BIOS setup utility hot keys can be used at any time during the setup navigation process. These keys include <F1>, <F2>, <Enter>, <ESC>, <Arrow> keys, and so on.



Note

Some of the navigation keys differ from one screen to another.

Hot Keys	Description
→← Left/Right	The Left and Right <Arrow> keys allow you to select a setup screen.
↑↓ Up/Down	The Up and Down <Arrow> keys allow you to select a setup screen or sub-screen.
+– Plus/Minus	The Plus and Minus <Arrow> keys allow you to change the field value of a particular setup item.
Tab	The <Tab> key allows you to select setup fields.
F1	The <F1> key allows you to display the General Help screen.
F2	The <F2> key allows you to Load Previous Values.
F3	The <F3> key allows you to Load Optimized Defaults.
F4	The <F4> key allows you to save any changes you have made and exit Setup. Press the <F4> key to save your changes.
Esc	The <Esc> key allows you to discard any changes you have made and exit the Setup. Press the <Esc> key to exit the setup without saving your changes.
Enter	The <Enter> key allows you to display or change the setup option listed for a particular setup item. The <Enter> key can also allow you to display the setup sub- screens.

6.3 Main Menu

When you first enter the setup utility, you will enter the Main setup screen. You can always return to the Main setup screen by selecting the Main tab. System Time/Date can be set up as described below. The Main BIOS setup screen is shown below.

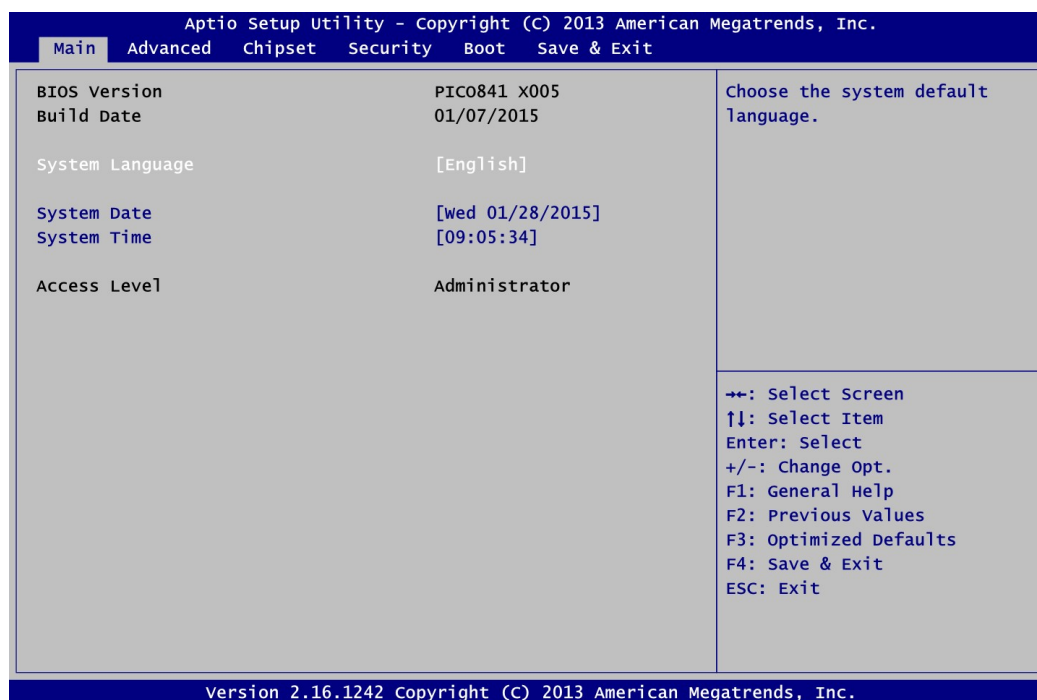

- **System Language**
Choose the system default language.
- **System Date/Time**
Use this option to change the system time and date. Highlight System Time or System Date using the <Arrow> keys. Enter new values through the keyboard. Press the <Tab> key or the <Arrow> keys to move between fields. The date must be entered in MM/DD/YY format. The time is entered in HH:MM:SS format.
- **Access Level**
Display the access level of current user.

6.4 Advanced Menu

The Advanced menu also allows users to set configuration of the CPU and other system devices. You can select any of the items in the left frame of the screen to go to the sub menus:

- ▶ ACPI Settings
- ▶ F81803 Super IO Configuration
- ▶ F81803 HW Monitor
- ▶ CPU Configuration
- ▶ IDE Configuration
- ▶ Miscellaneous Configuration
- ▶ Trusted Computing
- ▶ USB Configuration
- ▶ Utility Configuration

For items marked with “▶”, please press <Enter> for more options.

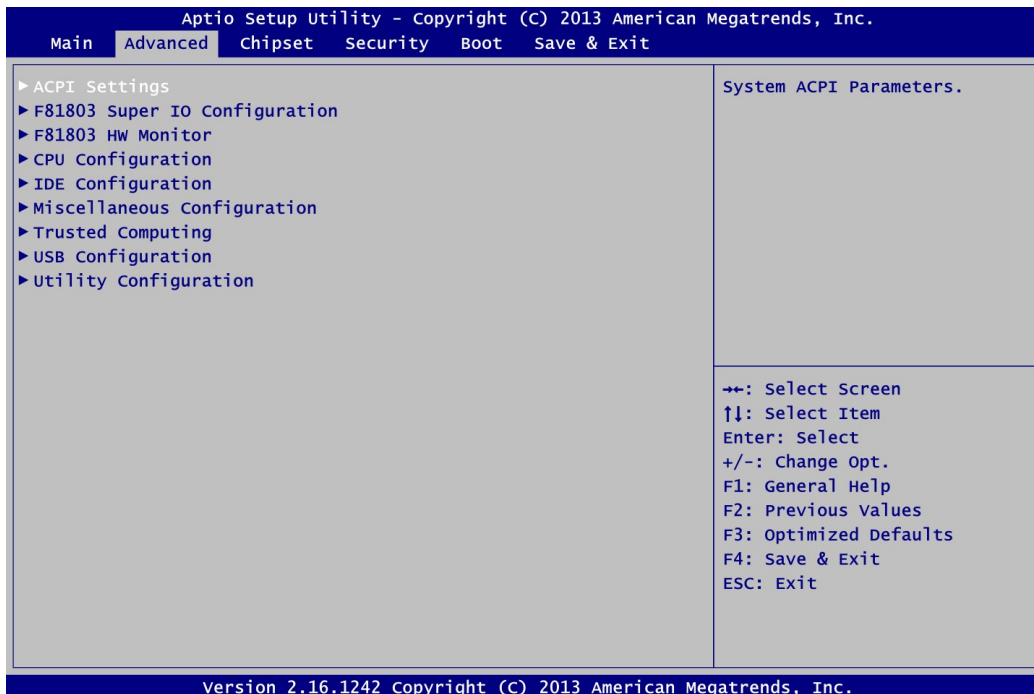

- **ACPI Settings**

You can use this screen to select options for the ACPI configuration, and change the value of the selected option. A description of the selected item appears on the right side of the screen.

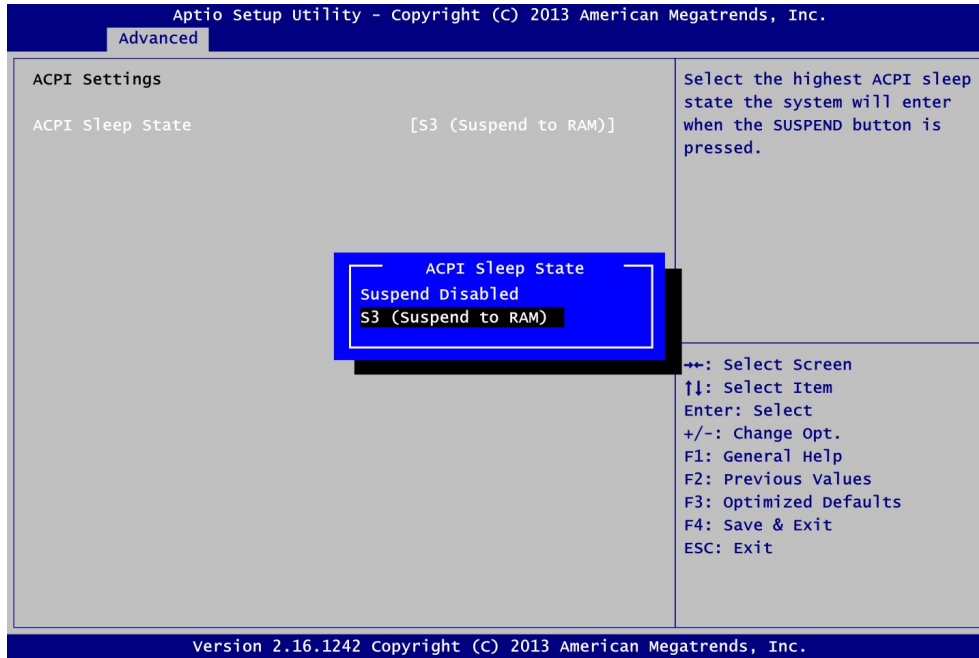

ACPI Sleep State

Select the ACPI (Advanced Configuration and Power Interface) sleep state. Configuration options are Suspend Disabled and S3 (Suspend to RAM). The default setting is S3 (Suspend to RAM); this option selects ACPI sleep state the system will enter when suspend button is pressed.

- **F81803 Super IO Configuration**

You can use this screen to select options for the Super IO Configuration, and change the value of the selected option. A description of the selected item appears on the right side of the screen. For items marked with “▶”, please press <Enter> for more options.

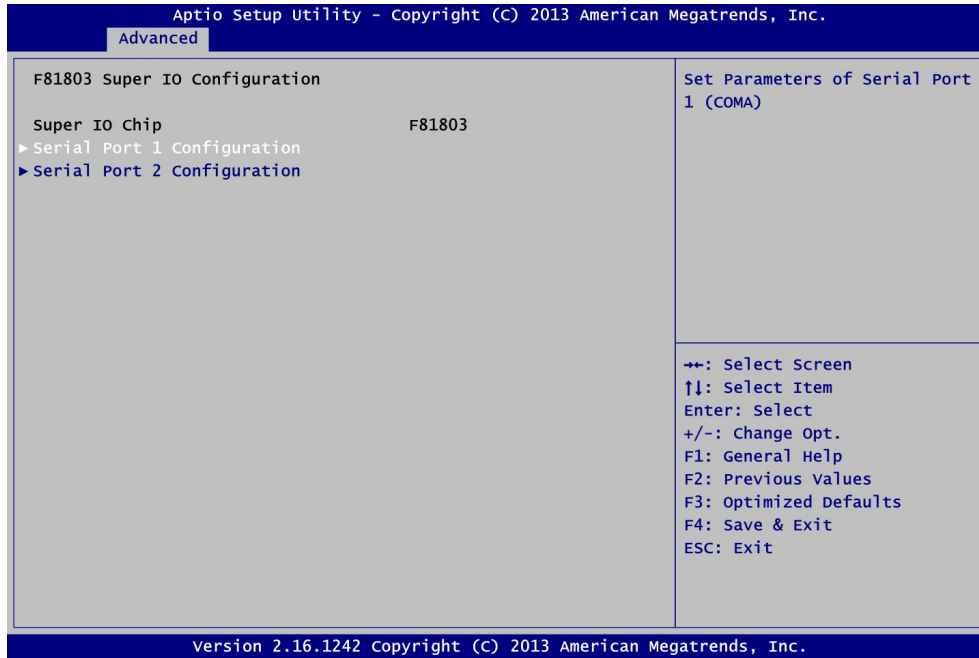

Serial Port 1~2 Configuration

Set parameters related to serial port 1~2.

- **Serial Port 1 Configuration**

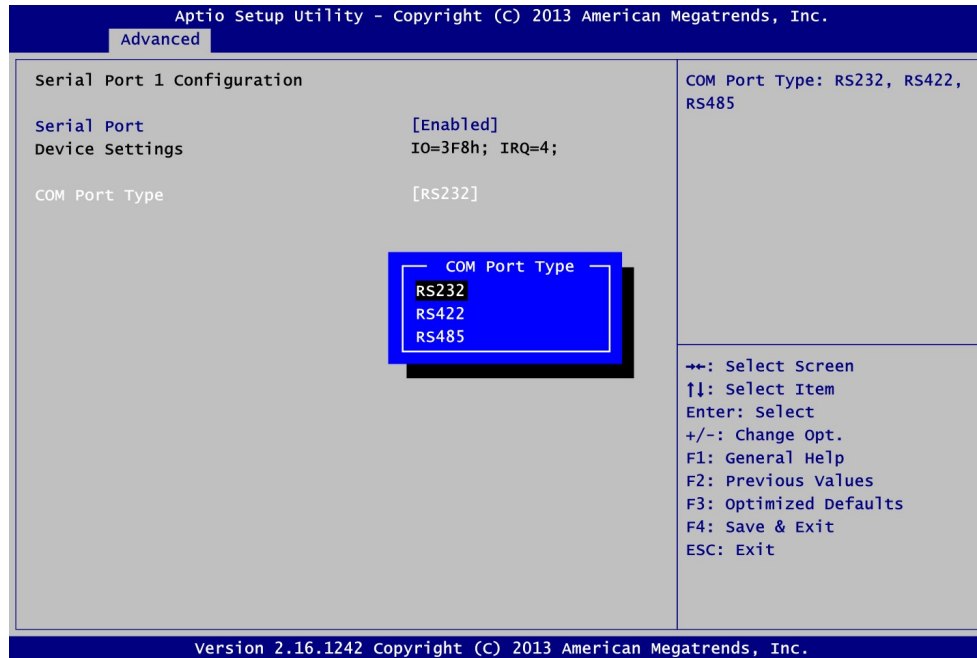

Serial Port

Enable or disable serial port 1. The optimal setting for base I/O address is 3F8h and for interrupt request address is IRQ4.

COM Port Type

Use this option to set RS-232/422/485 communication mode.

- Serial Port 2 Configuration

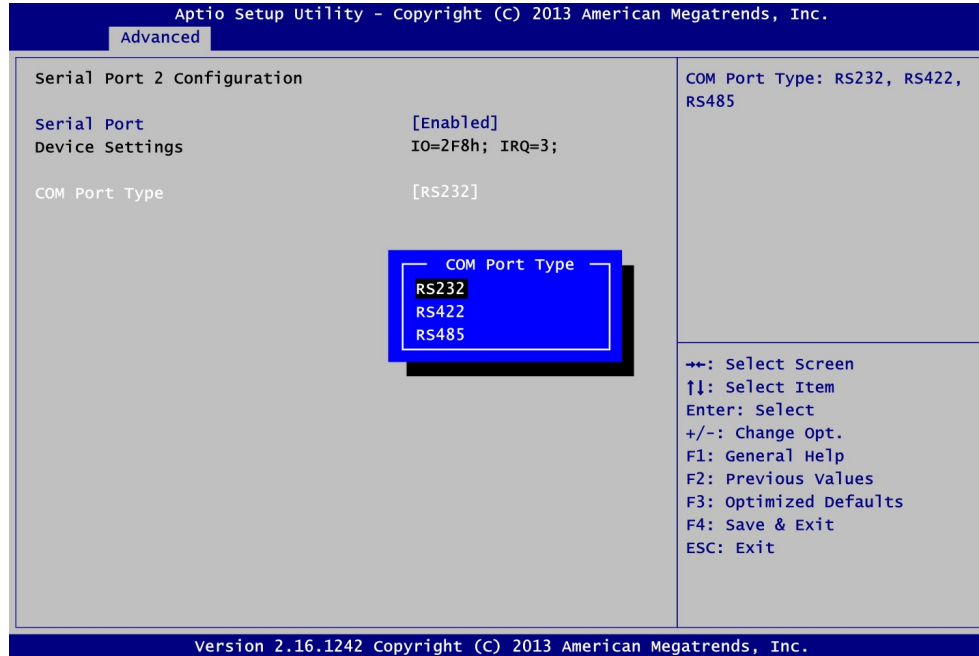
**Serial Port**

Enable or disable serial port 2. The optimal setting for base I/O address is 2F8h and for interrupt request address is IRQ3.

COM Port Type

Use this option to set RS-232/422/485 communication mode.

- **F81803 HW Monitor**

This screen monitors hardware health status.

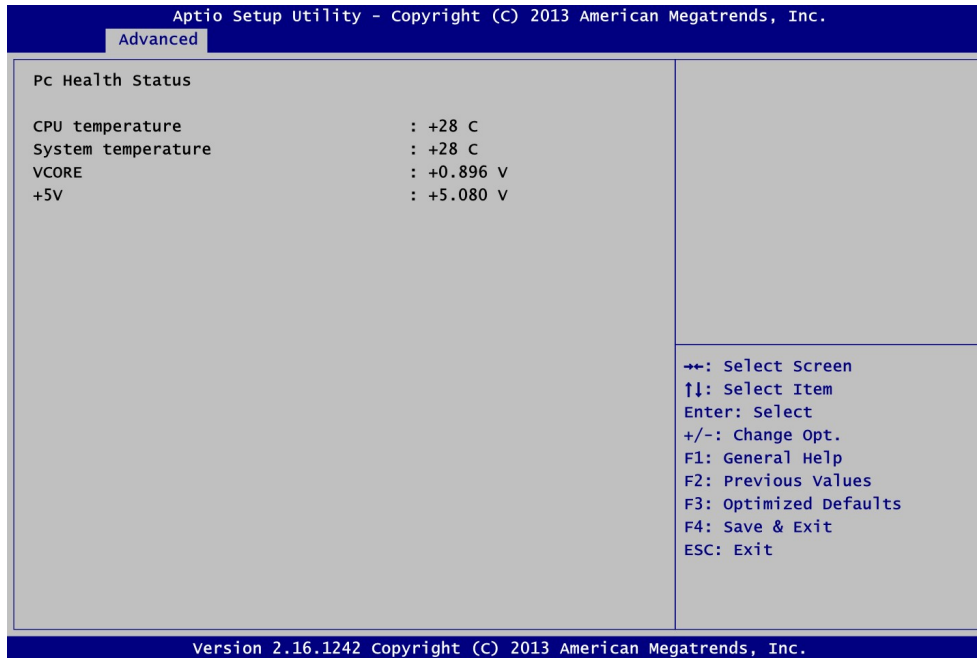

This screen displays the temperature of system and CPU, system voltages (VCORE and +5V).

- **CPU Configuration**

This screen shows the CPU Configuration, and you can change the value of the selected option.

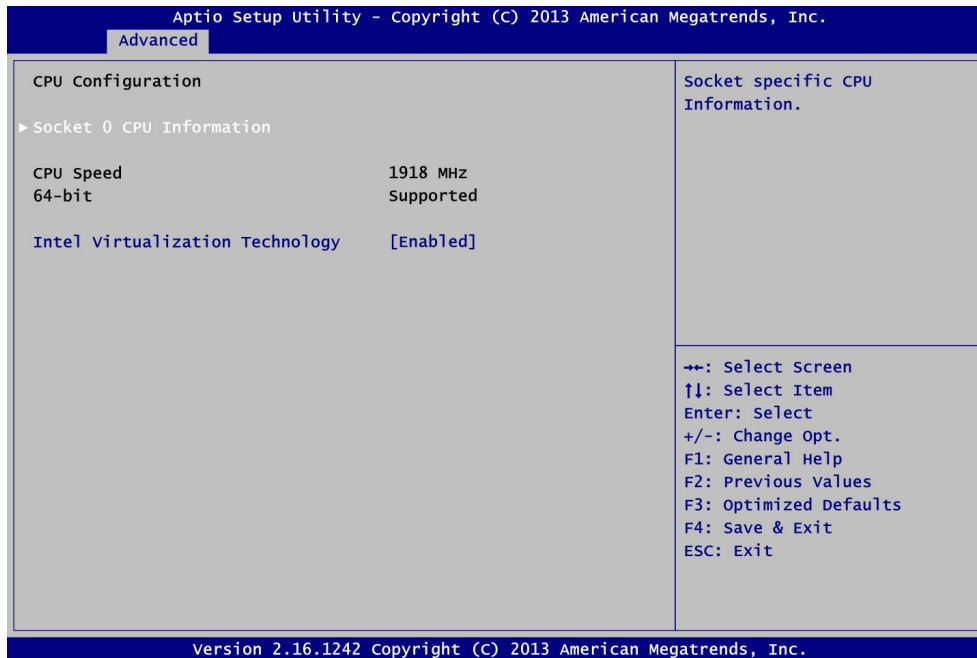

Socket 0 CPU Information

This item is for CPU information.

Intel Virtualization Technology

Enable or disable Intel Virtualization Technology. When enabled, a VMM (Virtual Machine Mode) can utilize the additional hardware capabilities. It allows a platform to run multiple operating systems and applications independently, hence enabling a computer system to work as several virtual systems.

- **Socket 0 CPU Information**
This screen shows CPU Information.

The screenshot displays the 'Advanced' menu of the Aptio Setup Utility. The 'Socket 0 CPU Information' section is selected and expanded, showing the following details:

Socket 0 CPU Information	
Intel(R) Atom(TM) CPU E3845 @ 1.91GHz	
CPU Signature	30679
Microcode Patch	901
Max CPU Speed	1910 MHz
Min CPU Speed	500 MHz
Processor Cores	4
Intel HT Technology	Not Supported
Intel VT-x Technology	Supported
L1 Data Cache	24 kB x 2
L1 Code Cache	32 kB x 2
L2 Cache	1024 kB x 2
L3 Cache	Not Present

Navigation instructions are listed on the right side of the screen:

- ←: Select Screen
- ↑↓: Select Item
- Enter: Select
- +/-: Change Opt.
- F1: General Help
- F2: Previous Values
- F3: Optimized Defaults
- F4: Save & Exit
- ESC: Exit

Version 2.16.1242 Copyright (C) 2013 American Megatrends, Inc.

- **IDE Configuration**

In the IDE Configuration menu, you can see the currently installed hardware in the SATA ports. During system boot up, the BIOS automatically detects the presence of SATA devices.

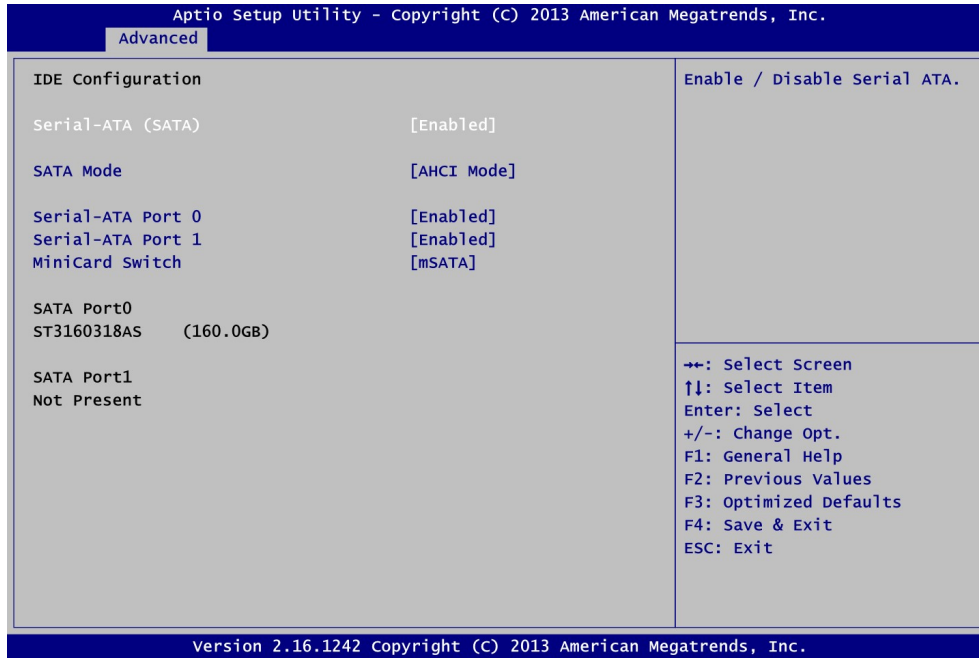

Serial-ATA (SATA)

Enable or disable the SATA Controller feature. The default is Enabled.

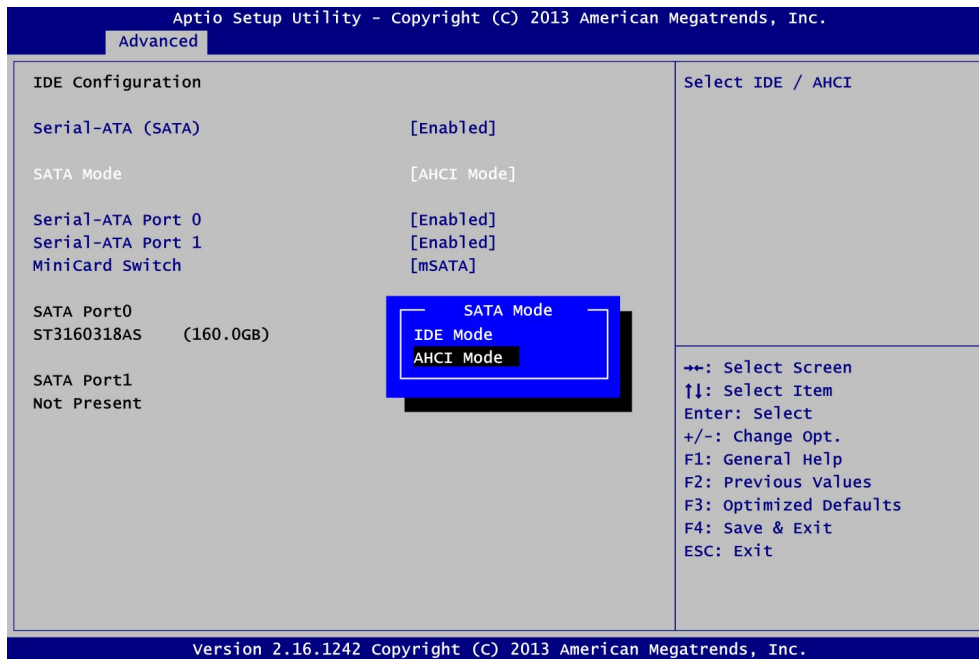

SATA Mode

Determine how SATA controller(s) operate. Operation mode options are IDE Mode and AHCI (Advanced Host Controller Interface) Mode. The default is AHCI Mode.

Serial-ATA Port 0~1

Enable or disable the onboard SATA port 0~1.

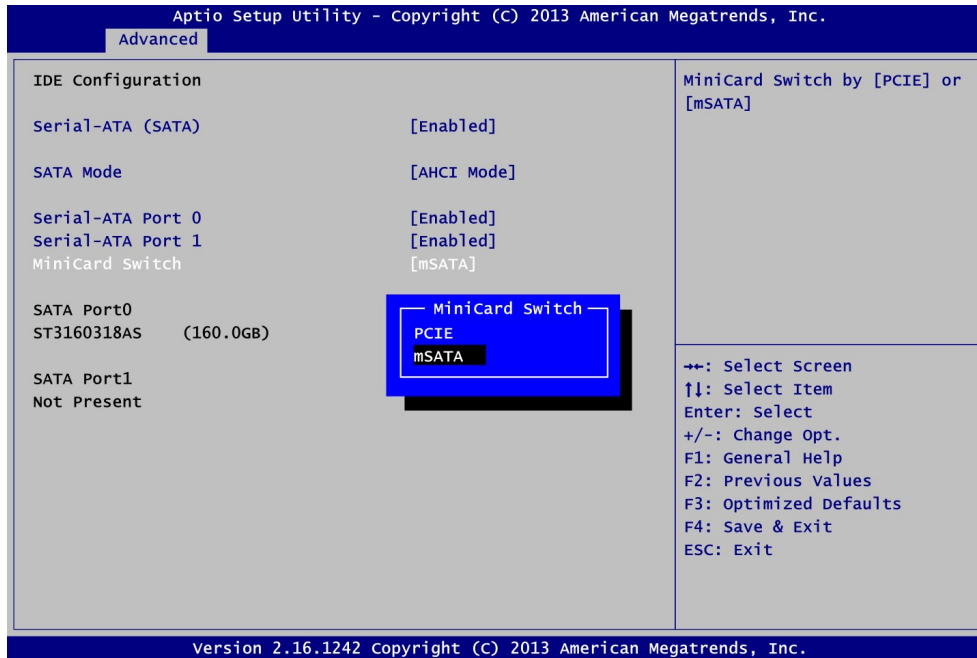

MiniCard Switch

This option appears only after SATA Port 1 is enabled. The default is mSATA. If the PCI-Express Mini Card via PCI-Express interface is needed to insert to SCN1 (see section 2.5.14), please change setting to PCIE.

- **Miscellaneous Configuration**

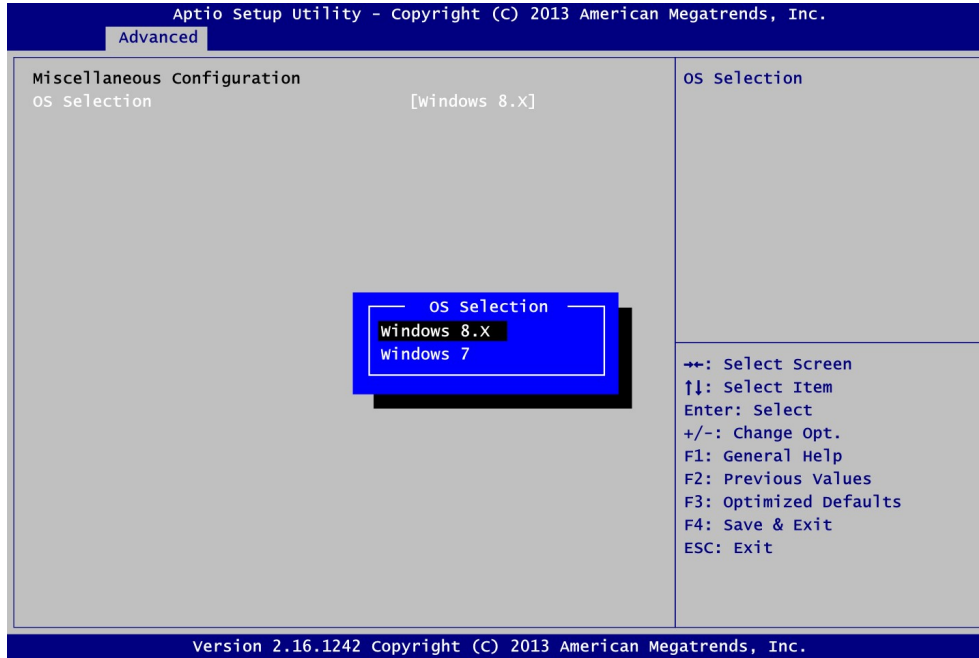

OS Selection

Use this item to select Windows® 8.x or Windows® 7 operating system. The default is Windows® 8.x.

- **Trusted Computing**

This screen provides function for specifying the TPM settings.

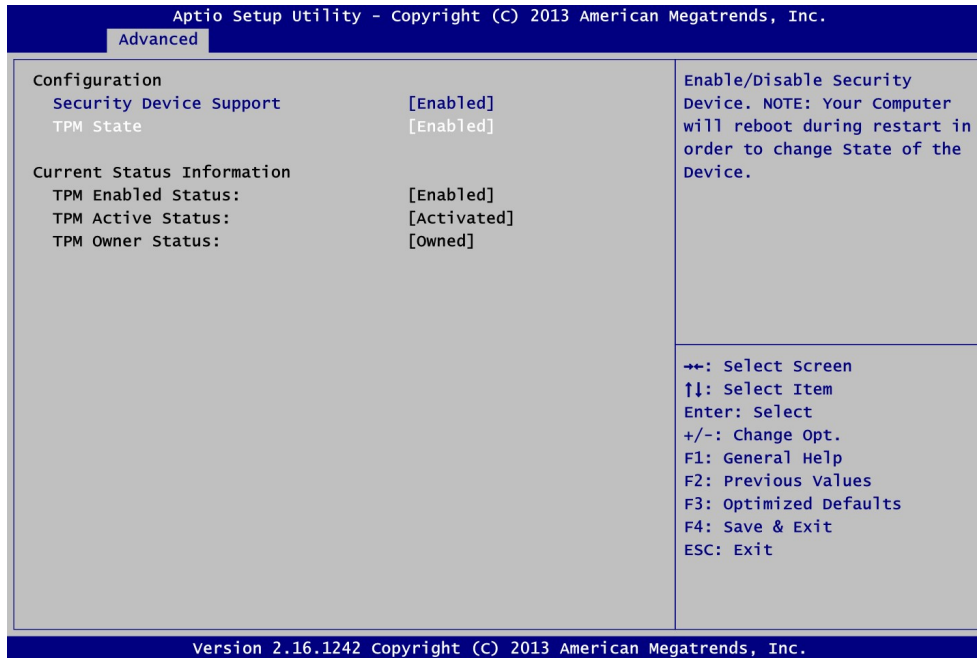

Security Device Support

Enable or disable BIOS support for security device. The default setting is Disabled.

TPM State

Once the Security Device Support is Enabled, TPM can be used by the operating system.

Current Status Information

Display current TPM status information.

● **USB Configuration**

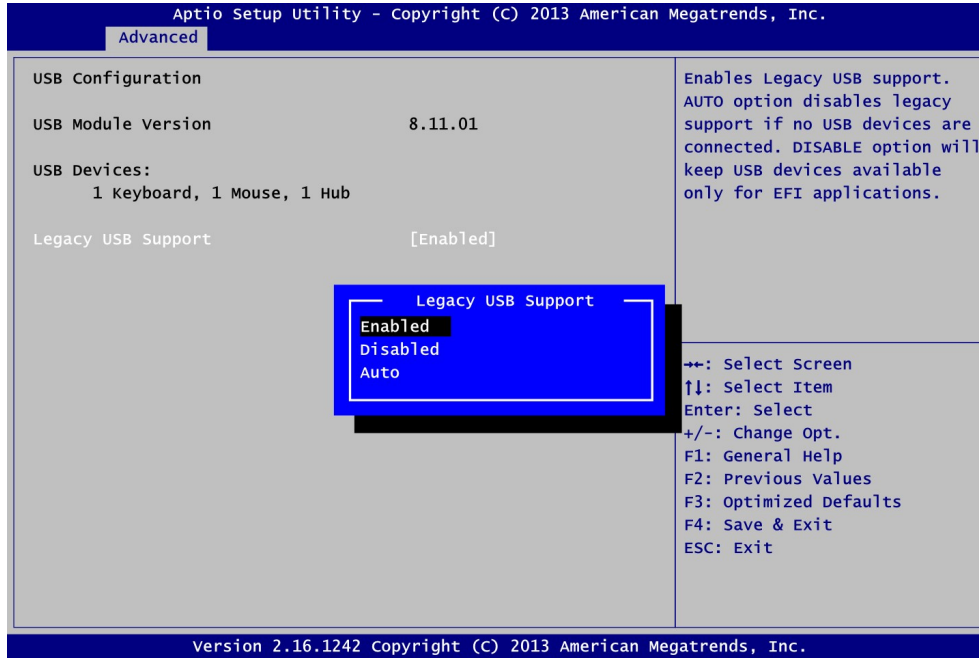

USB Devices

Display all detected USB devices.

Legacy USB Support

Use this item to enable or disable support for USB device on legacy operating system. The default setting is Enabled. Auto option disables legacy support if no USB devices are connected. Disable option will keep USB devices available only for EFI applications.

- **Utility Configuration**

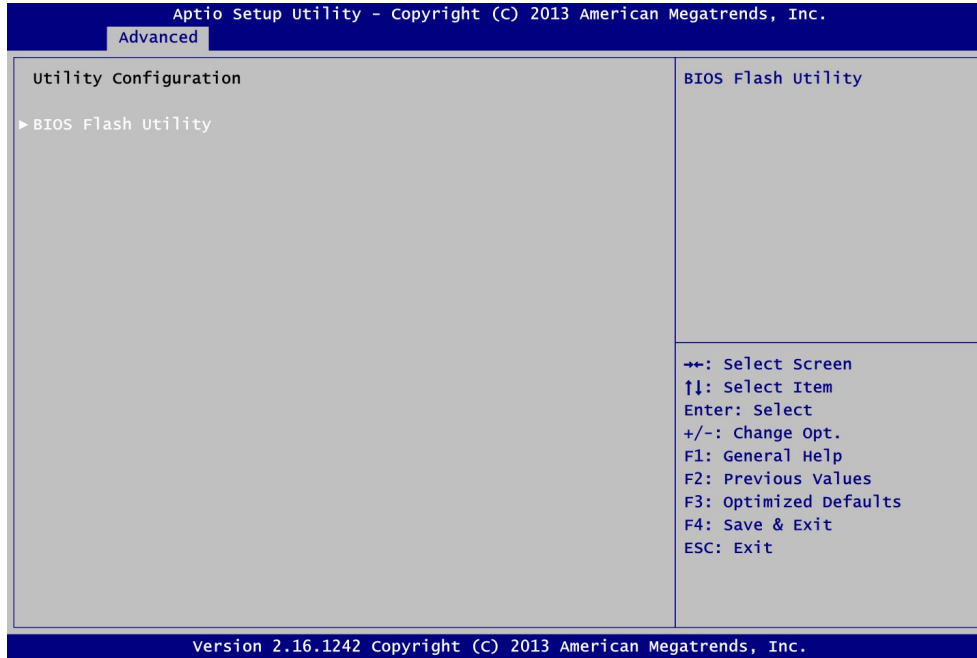

BIOS Flash Utility

BIOS flash utility configuration. For more detailed information, please refer to Appendix C.

6.5 Chipset Menu

The Chipset menu allows users to change the advanced chipset settings. You can select any of the items in the left frame of the screen to go to the sub menus:

- ▶ North Bridge
- ▶ South Bridge

For items marked with “▶”, please press <Enter> for more options.

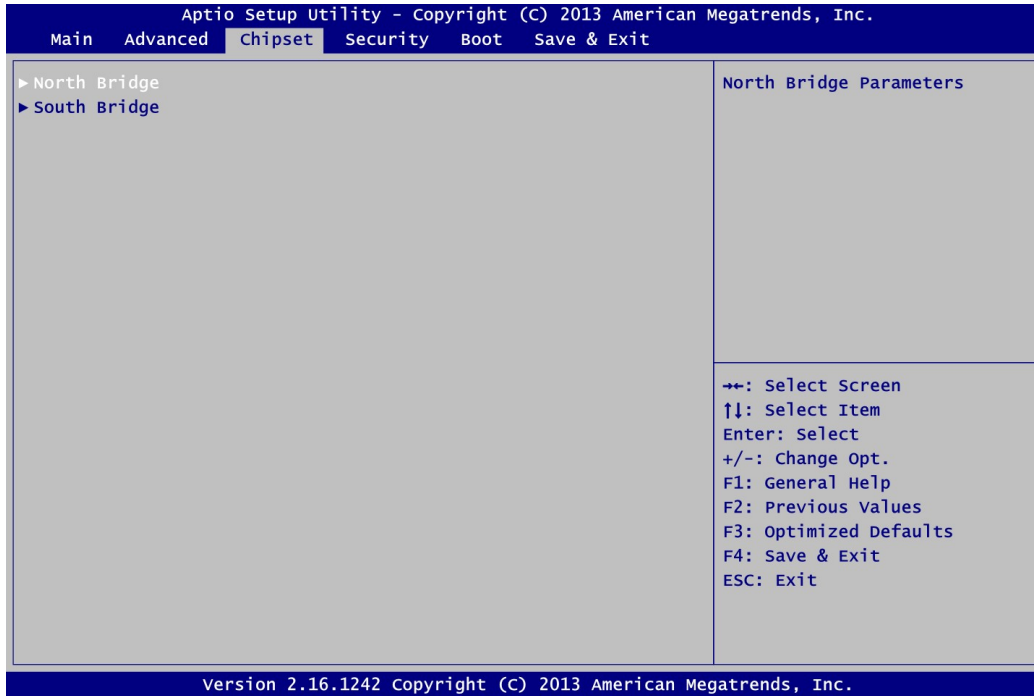

- **North Bridge**

This screen allows users to configure parameters of North Bridge chipset.

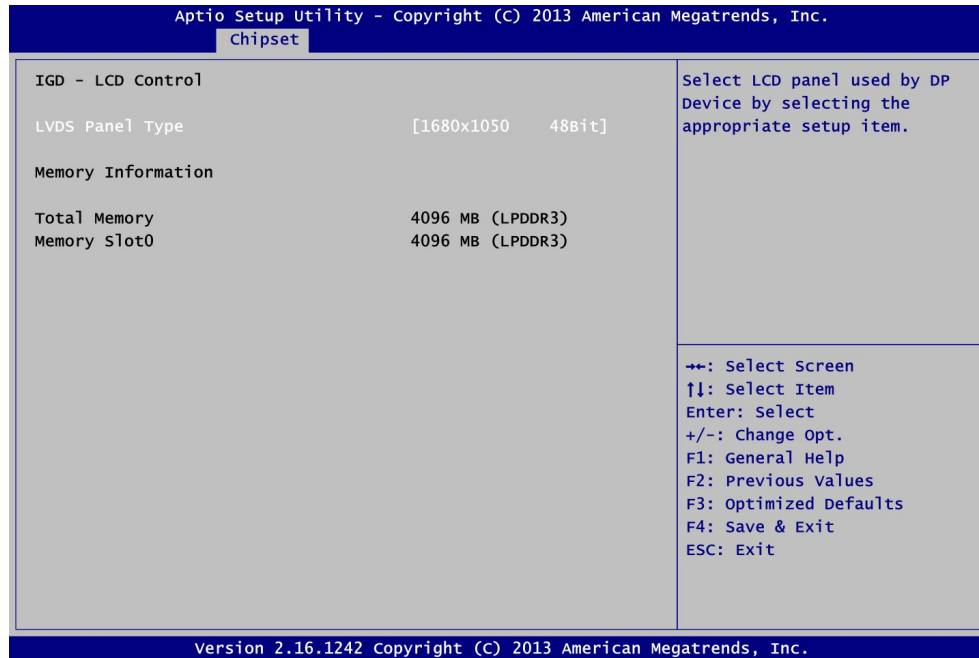

Memory Information

Show the information related to system memory.

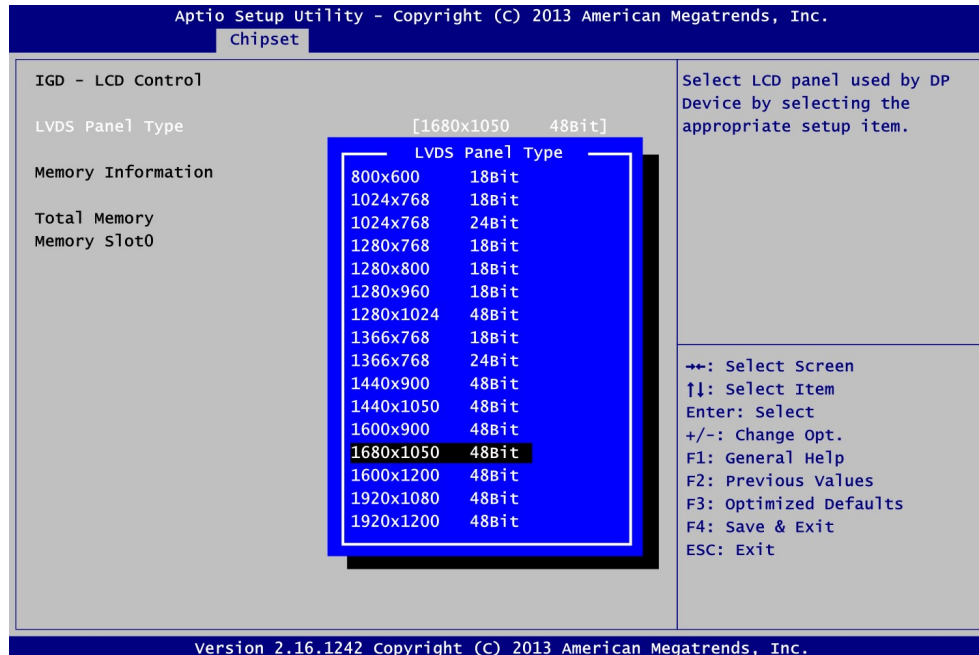

LVDS Panel Type

Select LVDS panel resolution; see the selection options in image above.

- **South Bridge**

This screen allows users to configure parameters of South Bridge chipset.

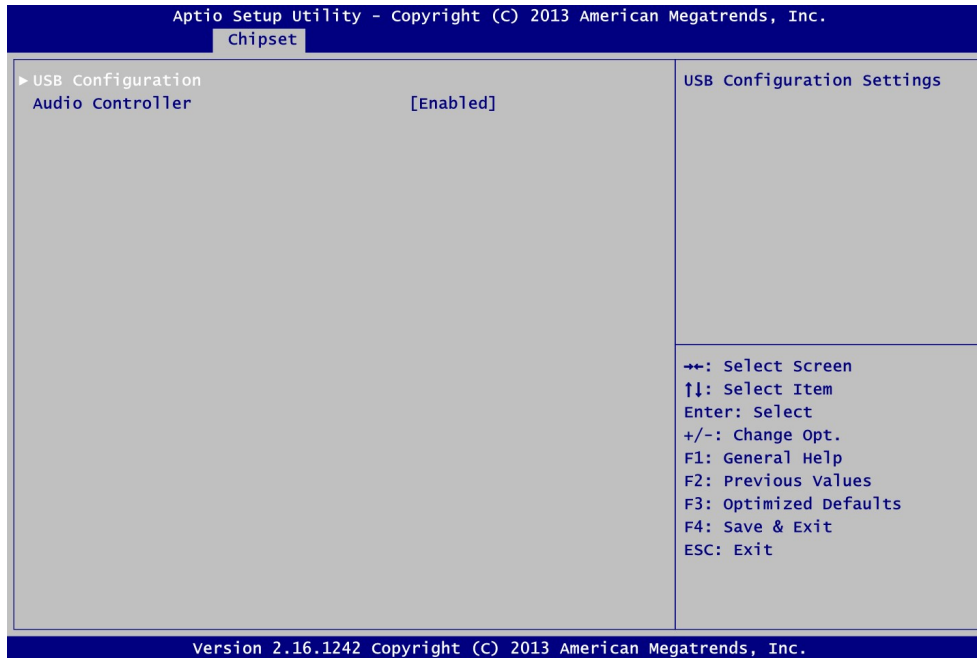
**USB Configuration**

This item is for USB configuration settings.

Audio Controller

Control detection of the audio device.

- **South Bridge – USB Configuration**



XHCI Mode

When Advanced\Miscellaneous Configuration\OS Selection is set to Windows® 8.x, XHCI mode is Enabled.

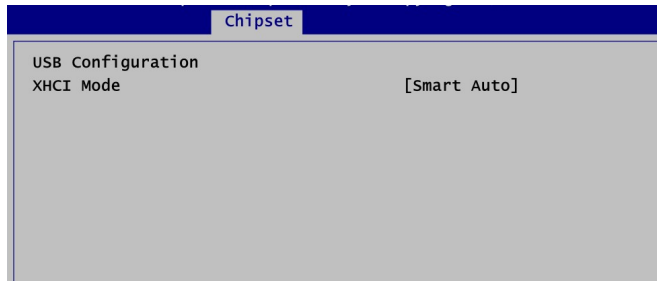

Meanwhile, when Advanced\Miscellaneous Configuration\OS Selection is set to Windows® 7, XHCI mode is Smart Auto.

6.6 Security Menu

The Security menu allows users to change the security settings for the system.



- **Administrator Password**
Set administrator password.
- **User Password**
Set user password.

6.7 Boot Menu

The Boot menu allows users to change boot options of the system.

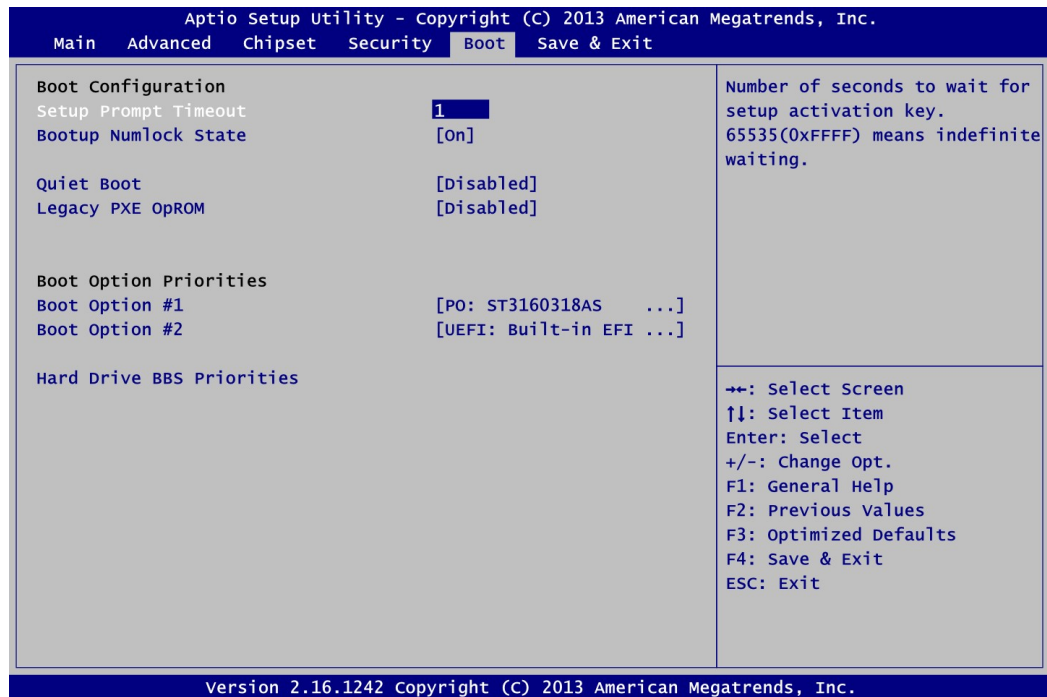

- Setup Prompt Timeout**
 Number of seconds to wait for setup activation key. 65535(0xFFFF) means indefinite waiting.
- Bootup NumLock State**
 Use this item to select the power-on state for the keyboard NumLock.
- Quiet Boot**
 Select to display either POST output messages or a splash screen during boot-up.
- Legacy PXE OpROM**
 Enable or disable the Preboot eXecution Environment (PXE) boot ROM function of the onboard LAN chip during system boots up.
- Boot Option Priorities [Boot Option #1, #2...]**
 These are settings for boot priority. Specify the boot device priority sequence from the available devices.
- Hard Drive BBS Priorities**
 Set the boot order of the specific devices in this group. This option appears only if at least one device of this group is detected.

6.8 Save & Exit Menu

The Save & Exit menu allows users to load your system configuration with optimal or fail-safe default values.

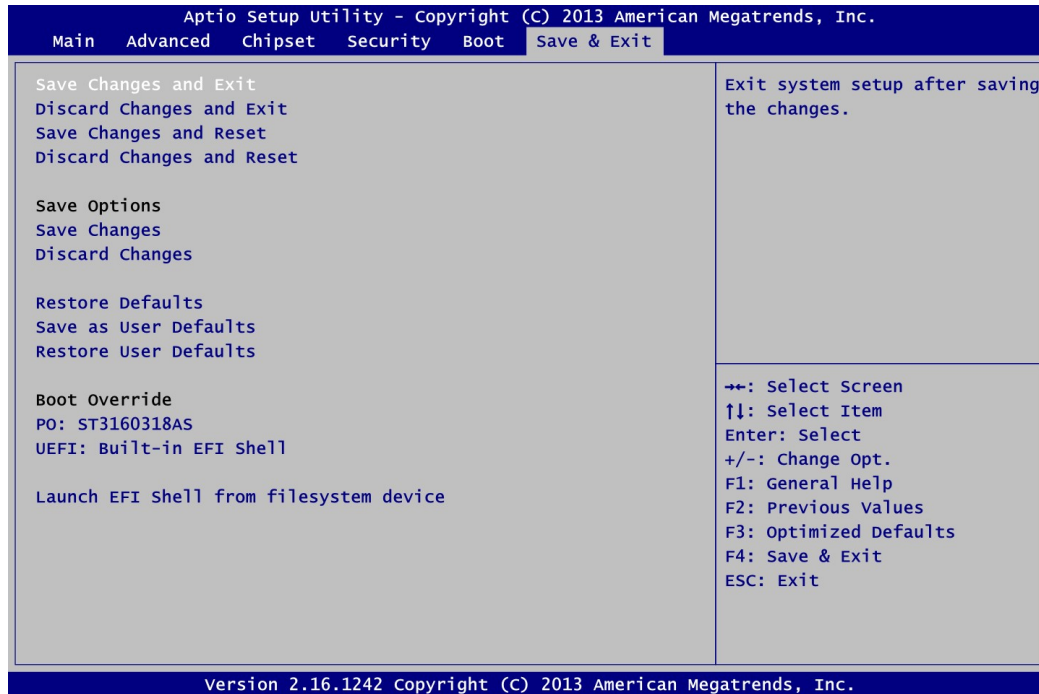

- Save Changes and Exit**
When you have completed the system configuration changes, select this option to leave Setup and return to Main Menu. Select Save Changes and Exit from the Save & Exit menu and press <Enter>. Select Yes to save changes and exit.
- Discard Changes and Exit**
Select this option to quit Setup without making any permanent changes to the system configuration and return to Main Menu. Select Discard Changes and Exit from the Save & Exit menu and press <Enter>. Select Yes to discard changes and exit.
- Save Changes and Reset**
When you have completed the system configuration changes, select this option to leave Setup and reboot the computer so the new system configuration parameters can take effect. Select Save Changes and Reset from the Save & Exit menu and press <Enter>. Select Yes to save changes and reset.
- Discard Changes and Reset**
Select this option to quit Setup without making any permanent changes to the system configuration and reboot the computer. Select Discard Changes and Reset from the Save & Exit menu and press <Enter>. Select Yes to discard changes and reset.
- Save Changes**
When you have completed the system configuration changes, select this option to save changes. Select Save Changes from the Save & Exit menu and press <Enter>. Select Yes to save changes.

- **Discard Changes**
Select this option to quit Setup without making any permanent changes to the system configuration. Select Discard Changes from the Save & Exit menu and press <Enter>. Select Yes to discard changes.
- **Restore Defaults**
It automatically sets all Setup options to a complete set of default settings when you select this option. Select Restore Defaults from the Save & Exit menu and press <Enter>.
- **Save as User Defaults**
Select this option to save system configuration changes done so far as User Defaults. Select Save as User Defaults from the Save & Exit menu and press <Enter>.
- **Restore User Defaults**
It automatically sets all Setup options to a complete set of User Defaults when you select this option. Select Restore User Defaults from the Save & Exit menu and press <Enter>.
- **Boot Override**
Select a drive to immediately boot that device regardless of the current boot order.
- **Launch EFI Shell from filesystem device**
Attempt to launch EFI Shell application (Shellx64.efi) from one of the available filesystem devices.

Appendix A

Watchdog Timer

A.1 About Watchdog Timer

Software stability is major issue in most application. Some embedded systems are not watched by human for 24 hours. It is usually too slow to wait for someone to reboot when computer hangs. The systems need to be able to reset automatically when things go wrong. The watchdog timer gives us solution.

The watchdog timer is a counter that triggers a system reset when it counts down to zero from a preset value. The software starts counter with an initial value and must reset it periodically. If the counter ever reaches zero which means the software has crashed, the system will reboot.

A.2 How to Use Watchdog Timer

The I/O port base addresses of watchdog timer are 2E (hex) and 2F (hex). The 2E (hex) and 2F (hex) are address and data port respectively.

Assume that program A is put in a loop that must execute at least once every 10ms. Initialize watchdog timer with a value bigger than 10ms. If the software has no problems; watchdog timer will never expire because software will always restart the counter before it reaches zero.

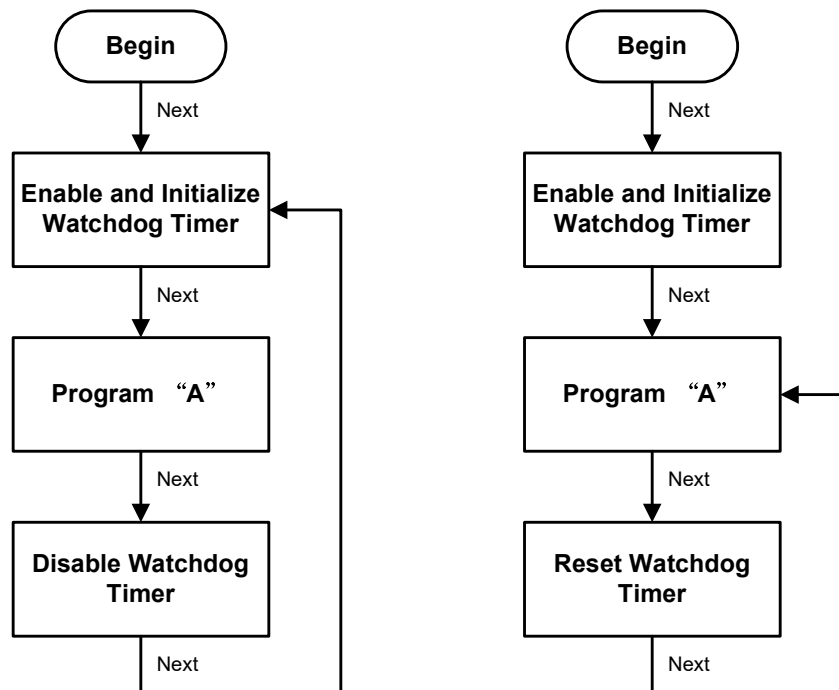

A.3 Sample Program

Assembly sample code :

```

;Enable WDT:
mov     dx,2Eh
mov     al,87             ;Un-lock super I/O
out     dx,al
out     dx,al

;Select Logic device:
mov     dx,2Eh
mov     al,07h
out     dx,al
mov     dx,2Fh
mov     al,07h
out     dx,al

;Enable WDT base address:
mov     dx,2Eh
mov     al,30h
out     dx,al
mov     dx,2Fh
mov     al,01h
out     dx,al

;Activate WDT:
mov     dx,2Eh
mov     al,0F0h
out     dx,al
mov     dx,2Fh
mov     al,80h
out     dx,al

;Set base timer :
mov     dx,2Eh
mov     al,0F6h
out     dx,al
mov     dx,2Fh
mov     al,Mh             ;M=00h,01h,...FFh (hex),Value=0 to 255
out     dx,al             ;(see below  Note)

;Set Second or Minute :
mov     dx,2Eh
mov     al,0F5h
out     dx,al
mov     dx,2Fh
mov     al,Nh             ;N=71h or 79h(see below  Note)
out     dx,al

```

 **Note:**

If **N=71h**, the time base is set to second.
M = time value
 00: Time-out Disable
 01: Time-out occurs after 1 second
 02: Time-out occurs after 2 seconds
 03: Time-out occurs after 3 seconds
 .
 FFh: Time-out occurs after 255 seconds

If **N**=79h, the time base is set to minute.

M = time value

00: Time-out Disable

01: Time-out occurs after 1 minute

02: Time-out occurs after 2 minutes

03: Time-out occurs after 3 minutes

.

.

FFh: Time-out occurs after 255 minutes

This page is intentionally left blank.

Appendix B

Windows® 7 Installation Guide

Before you install Windows® 7, please follow the instructions below:

1. Enter BIOS setup utility, and ensure that Advanced\Miscellaneous Configuration\OS Selection option is set to Windows® 7 (see section 6.4).

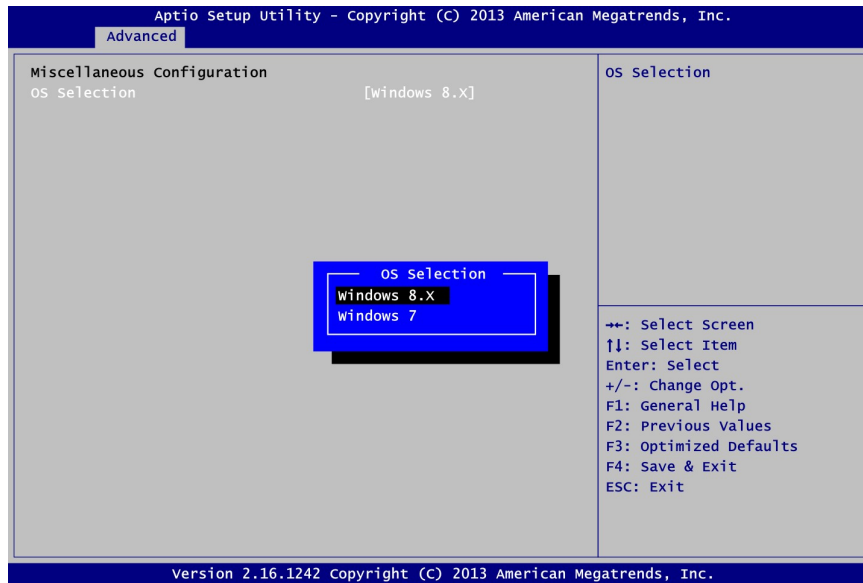

2. After that, go to Chipset\South Bridge to verify that XHCI Mode is Smart Auto.

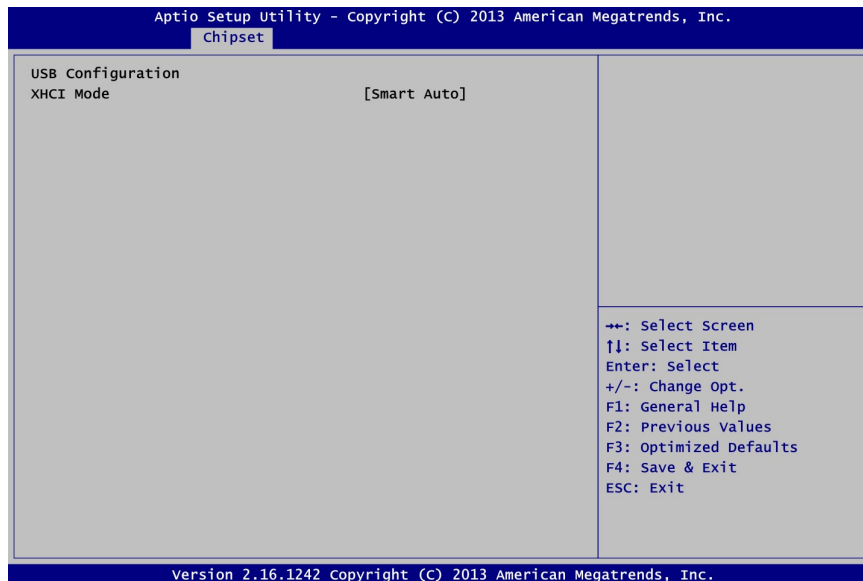

3. Save changes and exit BIOS utility.
4. Reboot and you may begin to install Windows® 7 on your computer. But please note that during installation, only the two USB ports (pin 13~16) at CN2 and USB1 at AX93283 can be used.
5. After Windows® 7 installation is complete, install XHCI driver (Intel_USB_3.0_xHC_Driver_3.0.4.65_MR4_PV) from the product information CD. After installing driver, all of the four USB ports can work properly.

Appendix C

BIOS Flash Utility

The BIOS Flash utility is a new helpful function in BIOS setup program. With this function you can easily update system BIOS without having to enter operating system. In this appendix you may learn how to do it in just a few steps. Please read and follow the instructions below carefully.

1. In your USB flash drive, create a new folder and name it “Axiomtek”, see figure below.

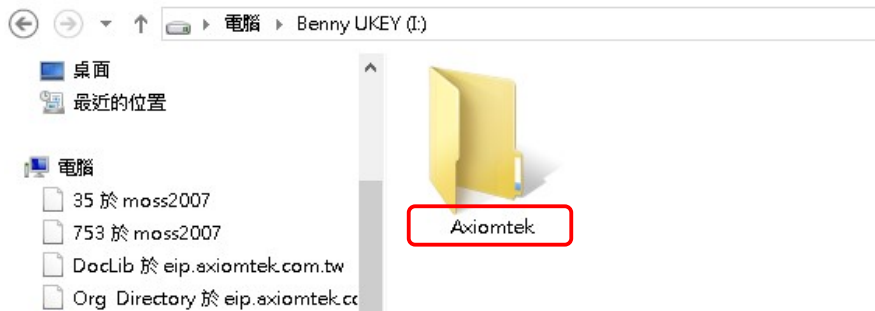

2. Copy BIOS ROM file (e.g. PICO843X.008) to “Axiomtek” folder.



3. Insert the USB flash drive to your system.
4. Enter BIOS setup menu and go to AdvancedUtility Configuration. Select BIOS Flash Utility and press <Enter>.

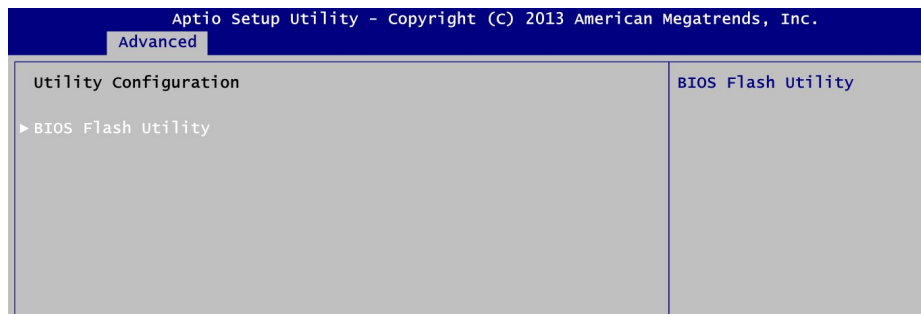

5. BIOS automatically detect all USB drive(s) attached to the system. In this example only one USB drive is attached to the system. That's why, you can see only one device is displayed in figure below.

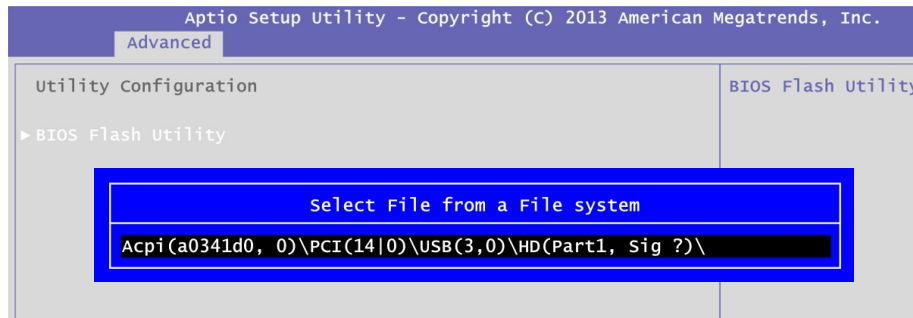

6. Select the USB drive containing BIOS ROM file you want to update using the <↑> or <↓> key. Then press <Enter> to get into "Axiomtek" folder.

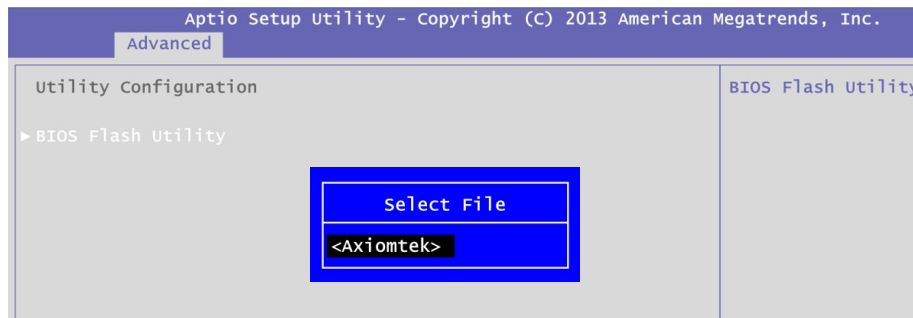

7. Now you can see the BIOS ROM file on the screen, press <Enter> to select.

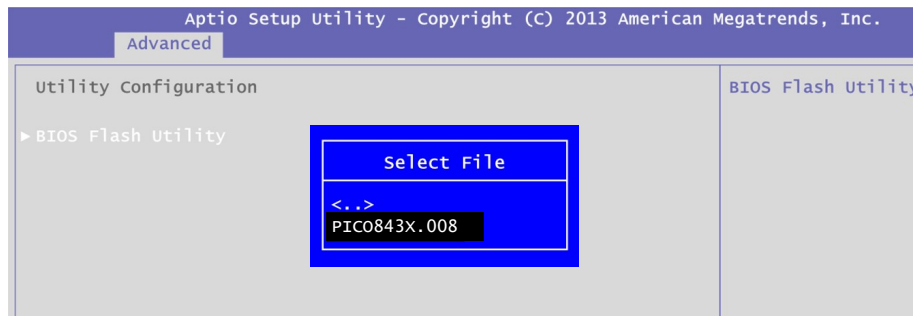

8. Select Start to flash system BIOS option to begin updating procedure.

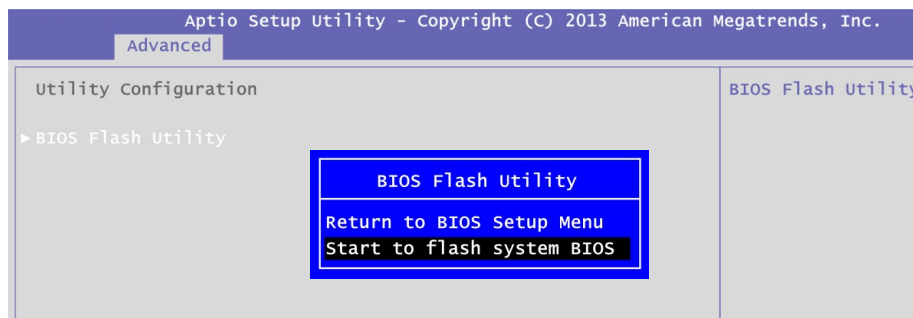

- Please wait while BIOS completes the entire flash update process: erase data, write new data and verify data.

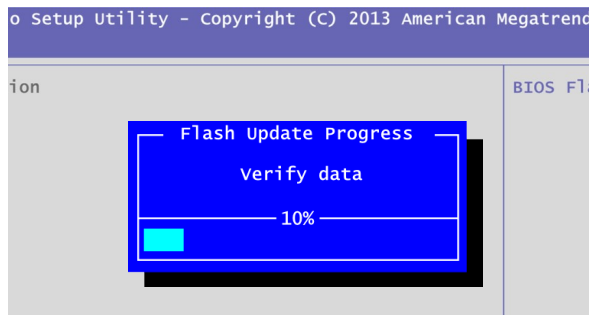
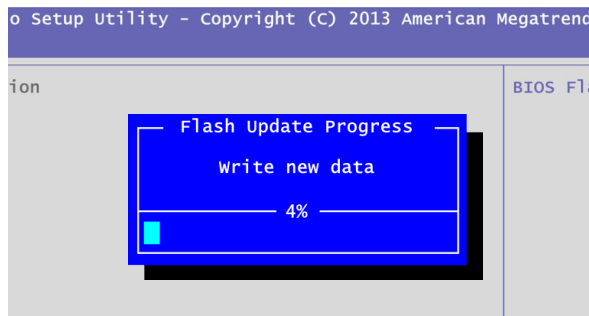
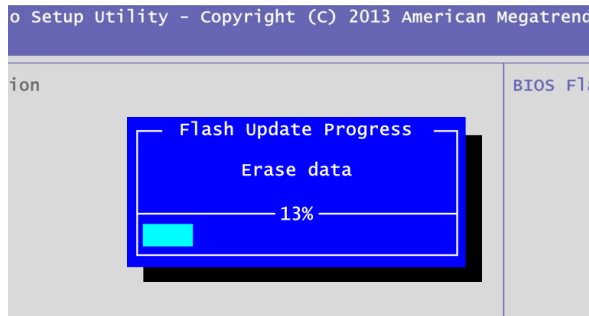

- When you see the following figure, press <Enter> to finish the update process. After that the system will shut down and restart immediately.

