



***AXIOMTEK***

## **CEB94018**

**COM Express™ Type 10  
Mini Carrier Board**

**User's Manual**



## **Disclaimers**

This manual has been carefully checked and believed to contain accurate information. Axiomtek Co., Ltd. assumes no responsibility for any infringements of patents or any third party's rights, and any liability arising from such use.

Axiomtek does not warrant or assume any legal liability or responsibility for the accuracy, completeness or usefulness of any information in this document. Axiomtek does not make any commitment to update the information in this manual.

Axiomtek reserves the right to change or revise this document and/or product at any time without notice.

No part of this document may be reproduced, stored in a retrieval system, or transmitted, in any form or by any means, electronic, mechanical, photocopying, recording, or otherwise, without the prior written permission of Axiomtek Co., Ltd.

## **CAUTION**

If you replace wrong batteries, it causes the danger of explosion. It is recommended by the manufacturer that you follow the manufacturer's instructions to only replace the same or equivalent type of battery, and dispose of used ones.

**©Copyright 2017 Axiomtek Co., Ltd.**

**All Rights Reserved**

**August 2017, Version A1**

**Printed in Taiwan**

## **ESD Precautions**

Computer boards have integrated circuits sensitive to static electricity. To prevent chipsets from electrostatic discharge damage, please take care of the following jobs with precautions:

- Do not remove boards or integrated circuits from their anti-static packaging until you are ready to install them.
- Before holding the board or integrated circuit, touch an unpainted portion of the system unit chassis for a few seconds. It discharges static electricity from your body.
- Wear a wrist-grounding strap, available from most electronic component stores, when handling boards and components.

## **Trademarks Acknowledgments**

Axiomtek is a trademark of Axiomtek Co., Ltd.

Intel<sup>®</sup> and Celeron<sup>®</sup> are trademarks of Intel Corporation.

Windows<sup>®</sup> is a trademark of Microsoft Corporation.

AMI is a trademark of American Megatrend Inc.

IBM, PC/AT, PS/2, VGA are trademarks of International Business Machines Corporation.

Other brand names and trademarks are the properties and registered brands of their respective owners.

# Table of Contents

---

Disclaimers.....	ii
ESD Precautions .....	iii
<b>Chapter 1 Introduction.....</b>	<b>1</b>
1.1 Features .....	2
1.2 Specifications .....	2
1.3 Utilities Supported .....	3
<b>Chapter 2 Board and Pin Assignments.....</b>	<b>5</b>
2.1 Board Dimensions and Fixing Holes .....	5
2.2 Board Layout .....	7
2.3 Installing PCI-Express Mini Card .....	8
2.4 Installing CEM Module and Thermal Solution.....	8
2.5 Jumper Settings .....	10
2.5.1 LVDS Voltage Selection (JP2).....	11
2.5.2 Restore BIOS Optimal Defaults (JP2).....	11
2.6 Connectors .....	12
2.6.1 Ethernet Ports (CN1 and CN2) .....	13
2.6.2 Audio Connector (CN3).....	13
2.6.3 USB 2.0 Connectors (CN4, CN5 and CN12) .....	13
2.6.4 DC Power Input Connector (CN6).....	13
2.6.5 Fan Power Connector (CN7).....	14
2.6.6 Half-size PCI-Express Mini Card and mSATA Connector (CN8) .....	14
2.6.7 Half-size PCI-Express Mini Card Connector (CN9) .....	15
2.6.8 VGA Connector (CN10).....	15
2.6.9 System Management Connector (CN11) .....	16
2.6.10 COM1 and COM2 Connector (CN13) .....	17
2.6.11 CMOS Battery Connector (BAT1) .....	17
2.6.12 SATA Power Connector (SCN1).....	17
2.6.13 SATA Connector (SCN2) .....	18
2.6.14 LVDS and Inverter Connector (SCN3) .....	18
2.6.15 SIM Card Socket (SCN4) .....	19
2.6.16 COM Express™ Type 10 Connector (SJ1) .....	19
<b>Chapter 3 AMI BIOS Functions .....</b>	<b>21</b>

# Chapter 1

## Introduction



The CEB94018 is a new COM Express™ Type 10 mini carrier board for embedded COM Express™ Type 10 Mini Module and fully compliant with the PCI Industrial Computer Manufacturers PICMG COM Express™ standard. The COM Express™ is an open industry standard for Computer-on-Modules, designed to be future proof and to provide a smooth transition path from legacy parallel interfaces to LVDS interfaces. In addition to the standard output signals for converting, CEB94018 provides two half-size PCI-Express Mini Card sockets and one SIM card socket for expansion purposes.

This board supports various I/O features: display interfaces (VGA and LVDS), two Gigabit/Fast Ethernet, HD audio codec, one SATA-600 interface, six USB 2.0 ports, digital I/O, two RS-232 TX/RX/RS-422/RS-485 ports.

With CEB94018, customers can develop their own applications and upgrade the system configuration in advance to meet faster time-to-market.

## 1.1 Features

- 2 Gigabit LAN ports
- SATA and mSATA
- LVDS/VGA
- 6 USB 2.0 ports
- 1 full-size PCI-Express Mini Card or 2 half-size PCI-Express Mini Cards
- 84 x 55mm mini size form factor

## 1.2 Specifications

- **CPU**
  - COM Express™ Type 10 module.
- **System Chipset**
  - On the COM Express™ module.
- **BIOS**
  - On the COM Express™ module.
- **System Memory**
  - On the COM Express™ module.
- **Onboard Multi I/O**
  - Two RS-232 TX/RX/RS-422/RS-485 ports.
- **Serial ATA**
  - One SATA-600 connector.
- **Ethernet**
  - Two wafer connectors as 1000/100/10Mbps Gigabit/Fast Ethernet interfaces.
- **Audio**
  - HD audio with line-out/MIC-in.
- **USB Interface**
  - Six USB ports with fuse protection and comply with USB Spec. Rev. 2.0.
- **SPI**
  - Not Supported.
- **I2C**
  - Supported.
- **Digital I/O**
  - Three inputs and three outputs.
- **Fan**
  - Make sure you use the matching CEB94018 heatsink w/fan (P/N: E39J010100) for connecting to Axiomtek CEM Type 10 module.

- **Display**
  - One 30-pin connector for 18/24-bit single channel LVDS and inverter signals.
  - One 16-pin wafer connector as VGA interface.
- **Expansion Interface**
  - Two half-size PCI-Express Mini Card sockets which comply with PCI-Express Mini Card Spec. V1.2.
  - One SIM card socket.
- **Battery**
  - Lithium 3V/220mAH.
- **Size**
  - 84 x 55mm.
- **Board Thickness**
  - 1.6mm.
- **Operation Temperature**
  - -40°C ~ +85°C (-104°F ~ 185°F).
- **Operation Humidity**
  - 10% ~ 95% relative humidity, non-condensing.



*All specifications and images are subject to change without notice.*

Note

## 1.3 Utilities Supported

- Audio driver
- Intel® Ethernet driver

**This page is intentionally left blank.**



# Chapter 2

## Board and Pin Assignments

### 2.1 Board Dimensions and Fixing Holes

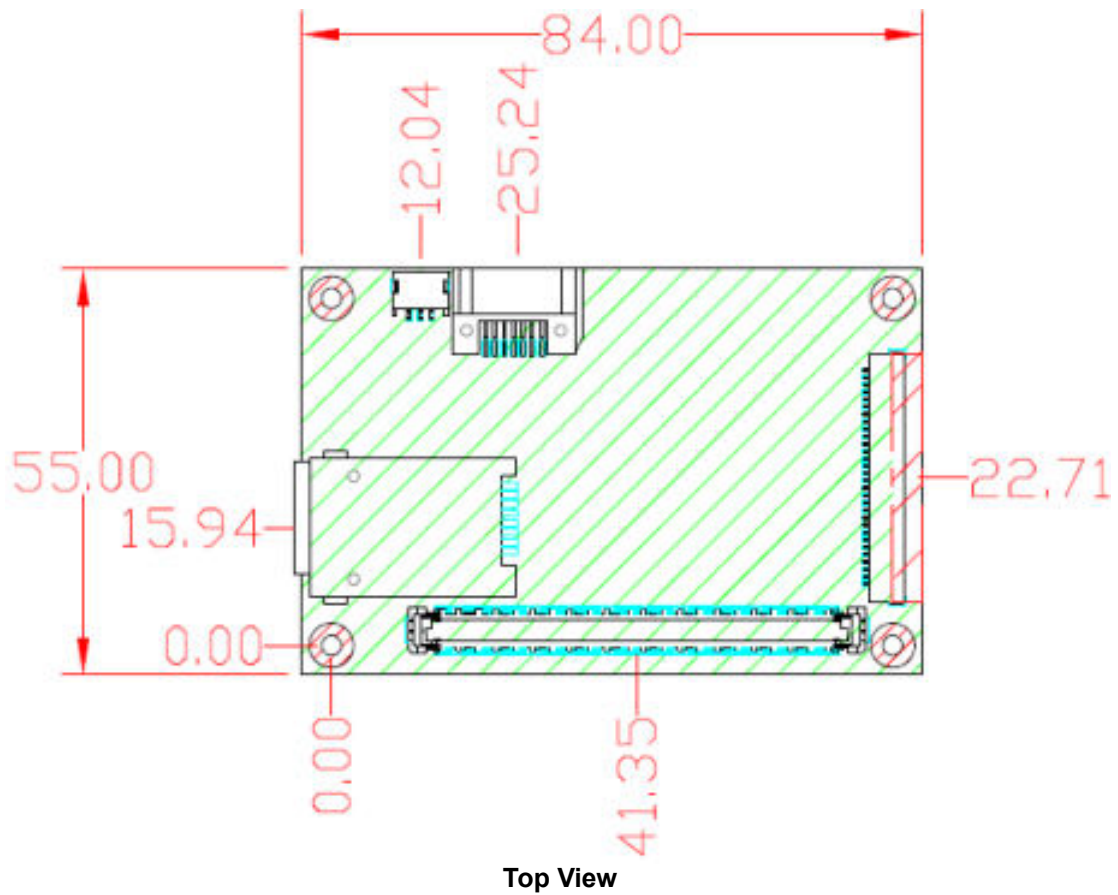

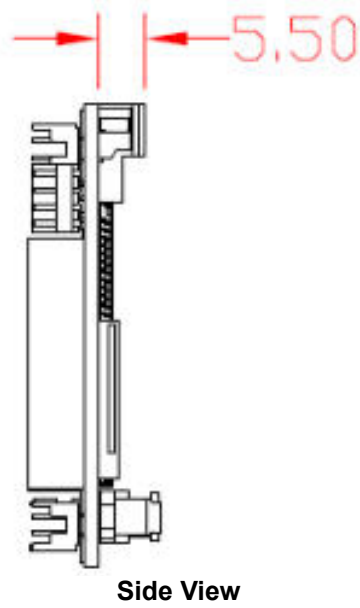
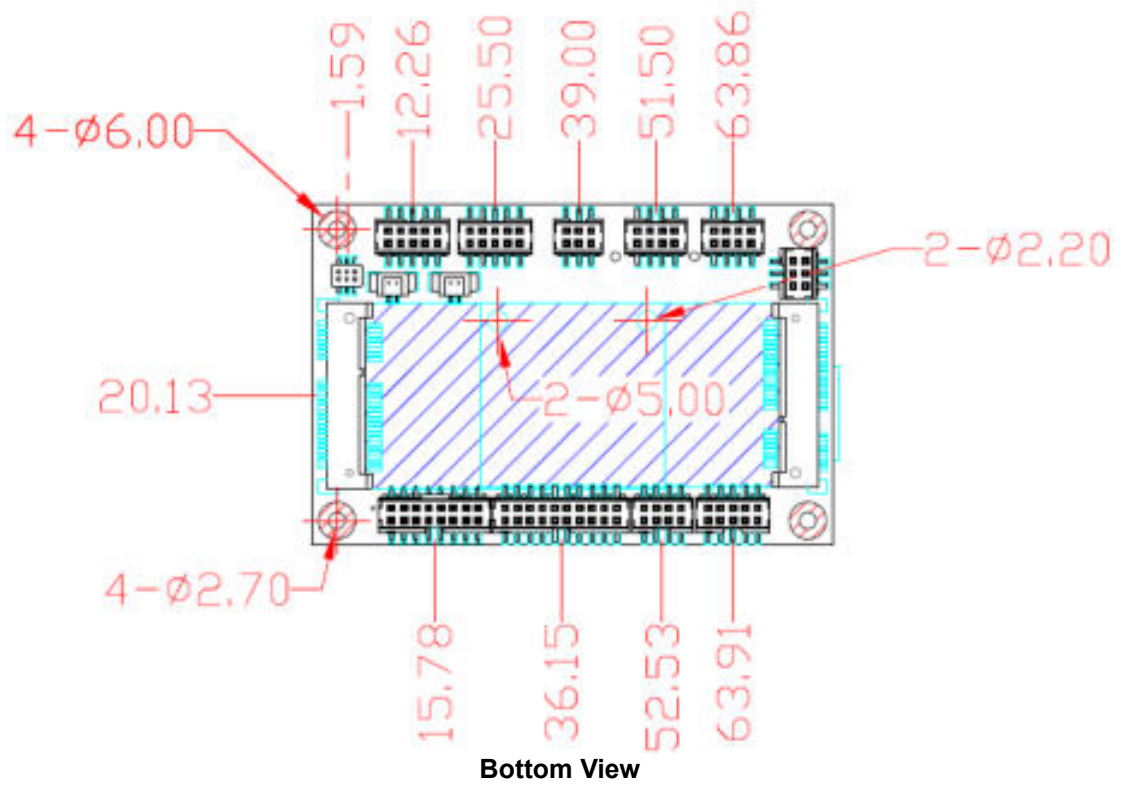

## 2.2 Board Layout

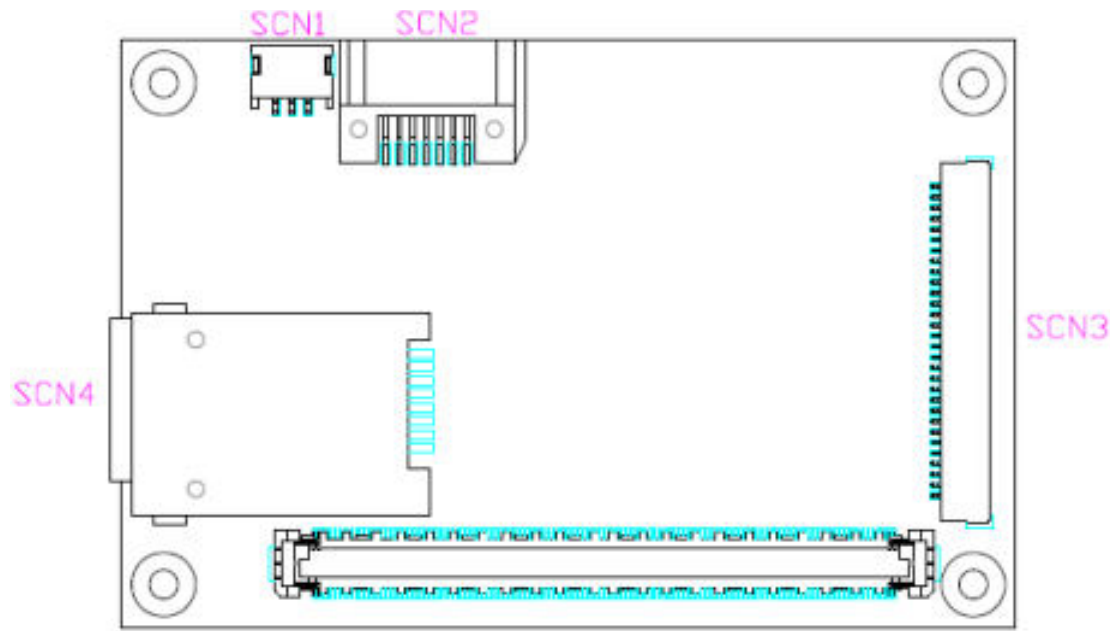

SJ1  
Top View

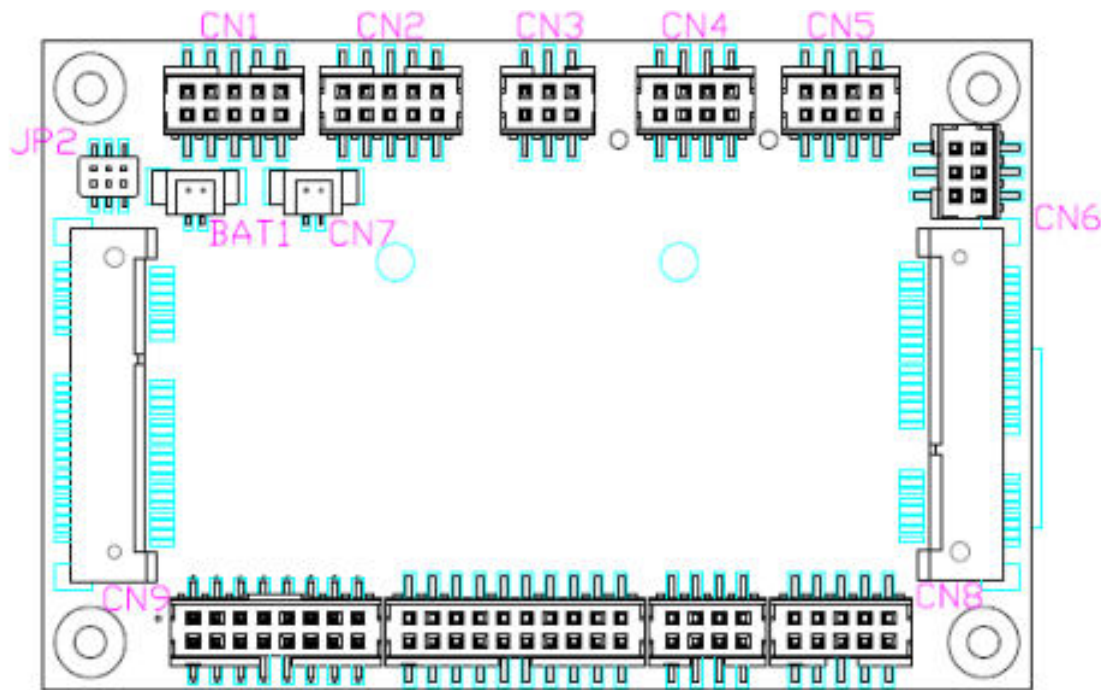

Bottom View

## 2.3 Installing PCI-Express Mini Card

The board is equipped with two PCI-Express Mini Card sockets. You can mount up to two half-size Mini Cards at the same time or mount one full-size Mini Card to either socket. To install Mini Card, please align contact edge of the Mini Card with the socket. Then gently insert the Mini Card into the target socket (CN8 or CN9) as indicated in image below:

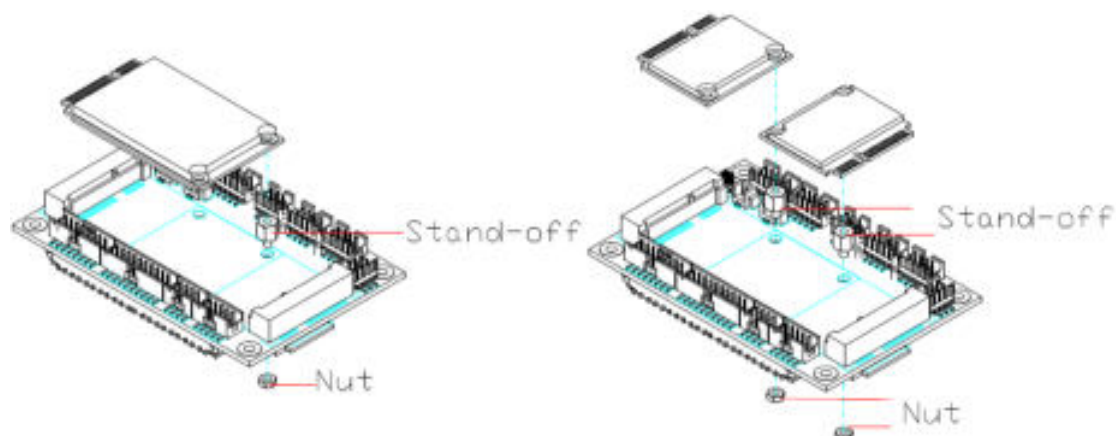

## 2.4 Installing CEM Module and Thermal Solution

For thermal dissipation, a thermal solution enables the components on the CEM module to dissipate heat efficiently. All heat generating components are thermally conducted to the heatsink in order to avoid hot spots. Below images illustrate how to install the thermal solution.

1. Each thermal solution is designed for a specific CEM module. The thermal pads on the heatspreader are designed to make contact with the necessary components on the CEM module. When mounting the heatspreader you must make sure that the thermal pads on the heatspreader make complete contact (no space between thermal pad and component) with the corresponding components on the CEM module. This is especially critical for CEM modules that have higher CPU speeds (for example 1.46GHz or more) to ensure that the heatspreader acts as a proper thermal interface for cooling solutions.
2. There is a protective plastic covering on the thermal pads. This must be removed before the heatspreader can be mounted. Before installing the heatspreader to the CPU module, please apply thermal grease on the CPU die. This CPU module has four assembly holes for installing heatspreader plate. Use the four screws to secure the heatspreader plate. Be careful not to over-tighten the screws. Then, apply thermal grease at the bottom of heatsink and secure the heatsink on the heatspreader by another four screws. The heatspreader and heatsink will be provided according to different CEM module.

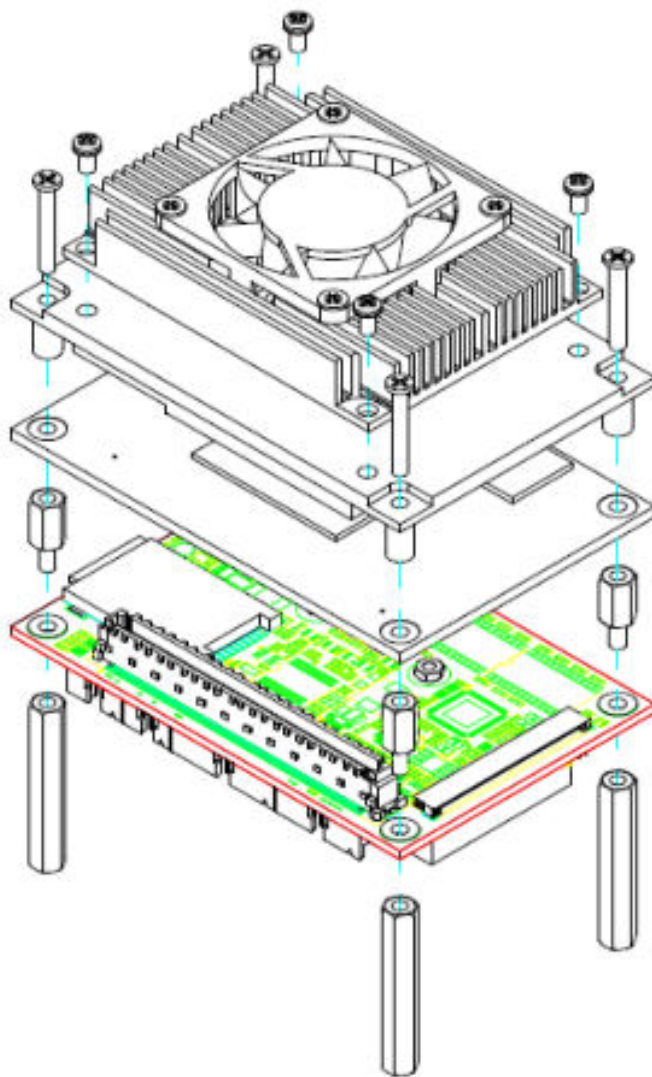

## 2.5 Jumper Settings

Jumper is a small component consisting of jumper clip and jumper pins. Install jumper clip on 2 jumper pins to close. And remove jumper clip from 2 jumper pins to open. Below illustration shows how to set up jumper.

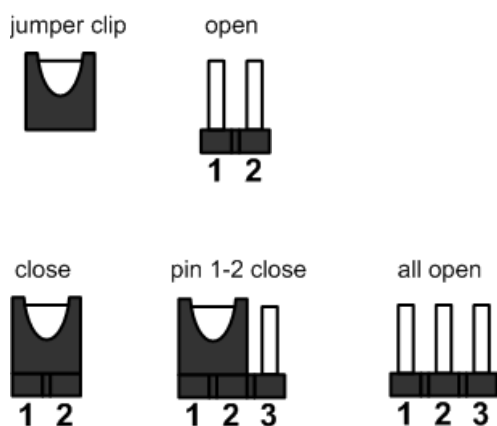

Properly configure jumper settings on the CEB94018 to meet your application purpose. Below you can find a summary table of all jumpers and onboard default settings.



Note

*Once the default jumper setting needs to be changed, please do it under power-off condition.*

Jumper	Description	Setting
JP2	LVDS +3.3V/+5V Voltage Selection Default: +3.3V	3-5 Close
	Restore BIOS Optimal Defaults Default: Normal Operation	4-6 Close

### 2.5.1 LVDS Voltage Selection (JP2)

The board supports voltage selection for flat panel displays. Use this jumper to set LVDS connector (SCN3) pin 1~2 VCCM to +3.3V or +5V. To prevent hardware damage, before connecting please make sure that the input voltage of flat panel is correct.

Function	JP2 Setting
+3.3V level (Default)	3-5 close
+5V level	1-3 close

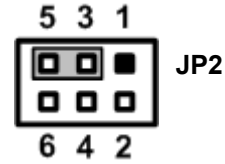

### 2.5.2 Restore BIOS Optimal Defaults (JP2)

Put jumper clip to pin 2-4 for a few seconds then move it back to pin 4-6. Doing this procedure can restore BIOS optimal defaults.

Function	JP2 Setting
Normal (Default)	4-6 close
Restore BIOS optimal defaults	2-4 close

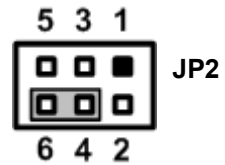

## 2.6 Connectors

Signals go to other parts of the system through connectors. Loose or improper connection might cause problems, please make sure all connectors are properly and firmly connected. Here is a summary table which shows all connectors on the hardware.

Connector	Description
CN1	Ethernet Port 2
CN2	Ethernet Port 1
CN3	Audio Connector
CN4	USB 2.0 Port 2 and 3
CN5	USB 2.0 Port 0 and 1
CN6	DC Power Input Connector
CN7	Fan Power Connector
CN8	Half-size PCI-Express Mini Card and mSATA Connector
CN9	Half-size PCI-Express Mini Card Connector
CN10	VGA Connector
CN11	System Management Connector
CN12	USB 2.0 Port 4 and 5
CN13	COM1 and COM2 Connector
BAT1	CMOS Battery Connector
SCN1	SATA Power Connector
SCN2	SATA Connector
SCN3	LVDS and Inverter Connector
SCN4	SIM Card Socket
SJ1	COM Express™ Type 10 Connector



### 2.6.1 Ethernet Ports (CN1 and CN2)

The board has two 2x5-pin (pitch=2.0mm) wafer connectors which are compliant with FCI 98424-G52-10ALF. The CN1 is for Ethernet port 2 and CN2 is for Ethernet port 1. Ethernet connection can be established by plugging one end of the Ethernet cable into this wafer connector and the other end (phone jack) to a 1000/100/10-Base-T hub.

Pin	Signal	Pin	Signal
1	MDI0-	2	MDI1-
3	MDI0+	4	MDI1+
5	LAN_GND	6	LAN_GND
7	MDI2-	8	MDI3-
9	MDI2+	10	MDI3+

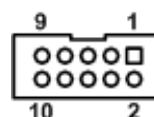

### 2.6.2 Audio Connector (CN3)

The CN3 is a 2x3-pin (pitch=2.0mm) wafer connector, which is compliant with FCI 98424-G52-06ALF, for audio interface.

Pin	Signal	Pin	Signal
1	Front_out_R	2	MIC_IN_R
3	Front_out_L	4	MIC_IN_L
5	GND	6	GND

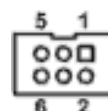

### 2.6.3 USB 2.0 Connectors (CN4, CN5 and CN12)

These are CN4 (for USB 2.0 port 2 and 3), CN5 (for USB 2.0 port 0 and 1) and CN12 (for USB 2.0 port 4 and 5) connectors which are compliant with FCI 98424-G52-08ALF. They are commonly used for installing USB peripherals such as keyboard, mouse, scanner, etc.

Pin	Signal	Pin	Signal
1	USB VCC (+5V level)	5	USB VCC (+5V level)
2	USB_D-	6	USB_D-
3	USB_D+	7	USB_D+
4	GND	8	GND

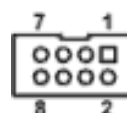

### 2.6.4 DC Power Input Connector (CN6)

This is a 2x3-pin (pitch=2.0mm) wafer connector, which is compliant with FCI 98424-G52-06ALF, for DC +5V (default power input) or 9V~14V (optional power input).

Pin	Signal	Pin	Signal
1	Power +	2	GND
3	Power +	4	GND
5	Power +	6	GND

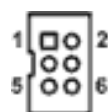

### 2.6.5 Fan Power Connector (CN7)

Fan is needed for cooling down CPU temperature. The CN7 is a 2-pin (pitch=1.25mm) wafer connector for fan power interface. Make sure that the cooler on CEM module match the 5V level fan power of CEB94018.

Pin	Signal
1	GND
2	+5V level

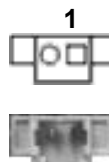

### 2.6.6 Half-size PCI-Express Mini Card and mSATA Connector (CN8)

This is a half-size PCI-Express Mini Card connector on the bottom side complying with PCI-Express Mini Card Spec. V1.2. It supports USB 2.0 and PCIe x1/SATA (mSATA).

Pin	Signal	Pin	Signal
1	WAKE#	2	+3.3VSB
3	No use	4	GND
5	No use	6	+1.5V
7	CLKREQ#	8	No use
9	GND	10	No use
11	REFCLK-	12	No use
13	REFCLK+	14	No use
15	GND	16	No use
17	No use	18	GND
19	No use	20	W_DISABLE#
21	GND	22	PERST#
23	SATA_RXP/PCIE_RXN	24	+3.3VSB
25	SATA_RXN/PCIE_RXP	26	GND
27	GND	28	+1.5V
29	GND	30	SMB_CLK
31	SATA_TXN/PCIE_TXN	32	SMB_DATA
33	SATA_TXP/PCIE_TXP	34	GND
35	GND	36	USB #x_D-
37	GND	38	USB #x_D+
39	+3.3VSB	40	GND
41	+3.3VSB	42	No use
43	GND	44	No use
45	No use	46	No use
47	No use	48	+1.5V
49	No use	50	GND
51	No use	52	+3.3VSB

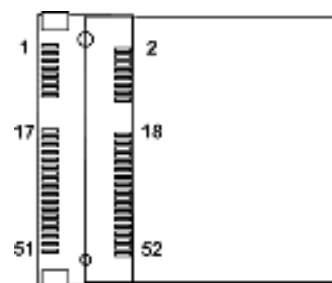

### 2.6.7 Half-size PCI-Express Mini Card Connector (CN9)

This is a half size PCI-Express Mini Card connector on the bottom side applying to either PCI-Express or USB 2.0. It also complies with PCI-Express Mini Card Spec. V1.2.

Pin	Signal	Pin	Signal
1	WAKE#	2	+3.3VSB
3	No use	4	GND
5	No use	6	+1.5V
7	CLKREQ#	8	SIM_PWR
9	GND	10	SIM_DATA
11	REFCLK-	12	SIM_CLK
13	REFCLK+	14	SIM_REST
15	GND	16	SIM_VPP
17	No use	18	GND
19	No use	20	W_DISABLE#
21	GND	22	PERST#
23	PE_RXN	24	+3.3VSB
25	PE_RXP	26	GND
27	GND	28	+1.5V
29	GND	30	SMB_CLK
31	PE_TXN	32	SMB_DATA
33	PE_TXP	34	GND
35	GND	36	USB #x_D-
37	GND	38	USB #x_D+
39	+3.3VSB	40	GND
41	+3.3VSB	42	No use
43	GND	44	No use
45	No use	46	No use
47	No use	48	+1.5V
49	No use	50	GND
51	No use	52	+3.3VSB

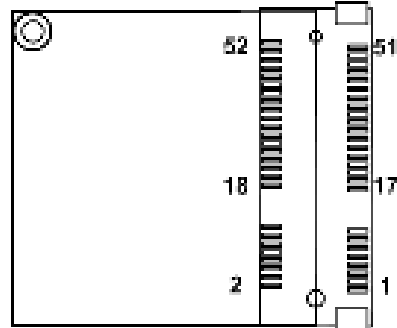

### 2.6.8 VGA Connector (CN10)

This is a 2x8-pin (pitch=2.0mm) wafer connector, which is compliant with FCI 98424-G52-16ALF, for VGA interface.

Pin	Signal	Pin	Signal
1	Red	2	GND
3	Green	4	N.C.
5	Blue	6	GND
7	VCC(+5V level)	8	DDC_SCL
9	GND	10	GND
11	GND	12	H Sync
13	GND	14	V Sync
15	DDC_SDA	16	

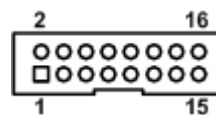

### 2.6.9 System Management Connector (CN11)

This is a 2x10-pin (pitch=2.0mm) wafer connector, which is compliant with FCI 98424-G52-20ALF, for system management interface.

Pin	Signal	Pin	Signal
1	PWRSW+	2	PWRSW-
3	HW RST+	4	HW RST-
5	LAN1_Active_LED+	6	LAN1_Active_LED-
7	LAN2_Active_LED+	8	LAN2_Active_LED-
9	PWRLED+	10	PWRLED-
11	VCC(+5V Level)	12	GND
13	GPO0	14	GPI0
15	GPO1	16	GPI1
17	GPO2	18	GPI2
19	I2C_CLK	20	I2C_DATA

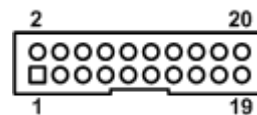

#### Power On/Off Button

Pin 1 and 2 connect the power button on front panel to the CPU board, which allows users to turn on or off power supply.

#### System Reset Switch

Pin 3 and 4 connect the case-mounted reset switch that reboots your computer without turning off the power switch. It is a better way to reboot your system for a longer life of system power supply.

#### LAN1/LAN2 Activity LED

This connection is linked to Ethernet activity LED on the control panel. LED flashes when Ethernet is being accessed. The pin 6 and 8 are assigned as cathode(-) and pin 5 and 7 are assigned as anode(+).

#### Power LED

Pin 9 connects anode(+) of LED and pin 10 connects cathode(-) of LED. The power LED lights up when the system is powered on.

#### Digital I/O

The board is equipped with 3 digital inputs (GPI0~GPI2) and 3 digital outputs (GPO0~GPO2) that meets requirements for a system customary automation control. The digital I/O can be configured to control cash drawers and sense warning signals from an Uninterrupted Power System (UPS), or perform store security control. You may use software programming to control these digital signals.

#### I2C Bus

The I2C is a simple 2-wire bus for the purpose of lightweight communication. Pin 20 is assigned as I2C data and pin 19 is assigned as I2C clock.

### 2.6.10 COM1 and COM2 Connector (CN13)

This is a 2x5-pin (pitch=2.0mm) wafer connector, which is compliant with FCI 98424-G52-10ALF, for COM1 and COM2 interface. The RS-232 mode is a 3-wire RS-232 consisting of only receive (RX), transmit (TX) and ground (GND). If you need COM1 and COM2 to support RS-422 or RS-485 mode, please change it with BIOS setting.

Pin	RS-232	RS-422	RS-485
1	No use	TX1-	Data1-
2	No use	TX2-	Data2-
3	RXD1	TX1+	Data1+
4	RXD2	TX2+	Data2-
5	GND	GND	No use
6	GND	GND	No use
7	TXD1	RX1+	No use
8	TXD2	RX2+	No use
9	No use	RX1-	No use
10	No use	RX2-	No use

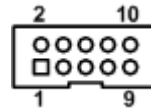

### 2.6.11 CMOS Battery Connector (BAT1)

This connector is for CMOS battery interface.

Pin	Signal
1	+3.3V
2	GND



### 2.6.12 SATA Power Connector (SCN1)

This is a 3-pin (pitch=1.5mm) wafer connector for interfacing to SATA 2.5" HDD power supply.

Pin	Signal
1	GND
2	N.C
3	+5V level

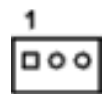

### 2.6.13 SATA Connector (SCN2)

The Serial Advanced Technology Attachment (Serial ATA or SATA) connector is computer bus interface for connecting to devices such as hard disk drive.

Pin	Signal
1	GND
2	SATA_TX+
3	SATA_TX-
4	GND
5	SATA_RX-
6	SATA_RX+
7	GND

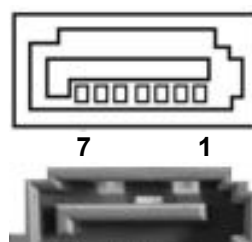

### 2.6.14 LVDS and Inverter Connector (SCN3)

This board has a 30-pin connector for LVDS LCD and inverter interface. It is strongly recommended to use the matching HRS DF19G-30P-1H connector for LVDS and inverter interface. Pin 1~2 VCCM can be set to +3.3V and +5V by setting JP2 (see section 2.5.1).

#### 18-bit single channel

Pin	Signal	Pin	Signal
1	VCCM	16	GND
2	VCCM	17	Channel A CLK-
3	GND	18	Channel A CLK+
4	GND	19	GND
5	Channel A D0-	20	Invert power (+5V Level)
6	Channel A D0+	21	Invert power (+5V Level)
7	GND	22	GND
8	Channel A D1-	23	BKL_EN
9	Channel A D1+	24	GND
10	GND	25	GND
11	Channel A D2-	26	GND
12	Channel A D2+	27	Brightness CTRL
13	GND	28	N.C
14	N.C	29	N.C.
15	N.C	30	N.C.



### 24-bit single channel

Pin	Signal	Pin	Signal
1	VCCM	16	GND
2	VCCM	17	Channel A CLK-
3	GND	18	Channel A CLK+
4	GND	19	GND
5	Channel A D0-	20	Invert power(+5V Level)
6	Channel A D0+	21	Invert power(+5V Level)
7	GND	22	GND
8	Channel A D1-	23	BKL_EN
9	Channel A D1+	24	GND
10	GND	25	GND
11	Channel A D2-	26	GND
12	Channel A D2+	27	Brightness CTRL
13	GND	28	N.C
14	Channel A D3-	29	N.C.
15	Channel A D3+	30	N.C.

### 2.6.15 SIM Card Socket (SCN4)

This board has SCN4 socket for inserting SIM Card. In order to work properly, the SIM Card must be used together with Mini Card which is inserted to CN9. It is mainly used in 3G wireless network application.

Pin	Signal
1	PWR
2	GND
3	RST
4	VPP
5	CLK
6	DATA
7	NC
8	NC

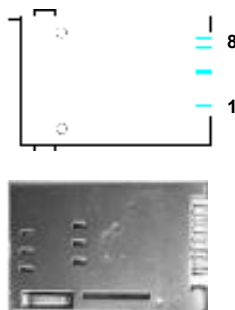

### 2.6.16 COM Express™ Type 10 Connector (SJ1)

The following table shows pin assignments for the 220-pin COM Express™ Type 10 connector.



CEB94018 COM Express™ Type 10 Mini Carrier Board

Pin	Signal	Pin	Signal	Pin	Signal	Pin	Signal
A1	GND (FIXED)	B1	GND (FIXED)	A56	N.C.	B56	N.C.
A2	GBE0_MDI3-	B2	GBE0_ACT#	A57	GND	B57	GPO2
A3	GBE0_MDI3+	B3	LPC_FRAME#	A58	N.C	B58	N.C
A4	N.C	B4	LPC_AD0	A59	N.C	B59	N.C
A5	N.C	B5	LPC_AD1	A60	GND (FIXED)	B60	GND (FIXED)
A6	GBE0_MDI2-	B6	LPC_AD2	A61	PCIE_TX2+	B61	PCIE_RX2+
A7	GBE0_MDI2+	B7	LPC_AD3	A62	PCIE_TX2-	B62	PCIE_RX2-
A8	N.C.	B8	N.C	A63	GPI1	B63	GPO3
A9	GBE0_MDI1-	B9	N.C.	A64	PCIE_TX1+	B64	PCIE_RX1+
A10	GBE0_MDI1+	B10	LPC_CLK	A65	PCIE_TX1-	B65	PCIE_RX1-
A11	GND (FIXED)	B11	GND (FIXED)	A66	GND	B66	WAKE0#
A12	GBE0_MDI0-	B12	PWRBTN#	A67	GPI2	B67	WAKE1#
A13	GBE0_MDI0+	B13	SMB_CK	A68	PCIE_TX0+	B68	PCIE_RX0+
A14	GBE0_CTREF	B14	SMB_DAT	A69	PCIE_TX0-	B69	PCIE_RX0-
A15	SUS_S3#	B15	N.C	A70	GND(FIXED)	B70	GND(FIXED)
A16	SATA0_TX+	B16	SATA1_TX+	A71	LVDS_A0+	B71	DDIO_PAIR0+
A17	SATA0_TX-	B17	SATA1_TX-	A72	LVDS_A0-	B72	DDIO_PAIR0-
A18	N.C.	B18	N.C.	A73	LVDS_A1+	B73	DDIO_PAIR1+
A19	SATA0_RX+	B19	N.C	A74	LVDS_A1-	B74	DDIO_PAIR1-
A20	SATA0_RX-	B20	N.C	A75	LVDS_A2+	B75	N.C
A21	GND (FIXED)	B21	GND (FIXED)	A76	LVDS_A2-	B76	N.C
A22	N.C	B22	N.C	A77	LVDS_VDD_EN	B77	N.C.
A23	N.C	B23	N.C	A78	LVDS_A3+	B78	N.C.
A24	N.C	B24	PWR_OK	A79	LVDS_A3-	B79	LVDS_BKLT_EN
A25	N.C	B25	N.C	A80	GND(FIXED)	B80	GND(FIXED)
A26	N.C	B26	N.C	A81	LVDS_A_CK+	B81	N.C
A27	N.C	B27	WDT	A82	LVDS_A_CK-	B82	N.C
A28	(S)ATA_ACT#	B28	N.C.	A83	N.C.	B83	LVDS_BKLT_CTRL
A29	AC/HDA_SYNC	B29	N.C.	A84	N.C.	B84	VCC_5V_SBY
A30	AC/HDA_RST#	B30	AC/HDA_SDIN0	A85	GPI3	B85	VCC_5V_SBY
A31	GND (FIXED)	B31	GND (FIXED)	A86	N.C.	B86	VCC_5V_SBY
A32	AC/HDA_BITCLK	B32	N.C	A87	N.C.	B87	VCC_5V_SBY
A33	AC/HDA_SDOOUT	B33	I2C_CK	A88	PCIE_CK_REF+	B88	BIOS_DIS1#
A34	N.C	B34	I2C_DAT	A89	PCIE_CK_REF-	B89	DDIO_HPD
A35	N.C.	B35	N.C	A90	GND (FIXED)	B90	GND (FIXED)
A36	USB6-	B36	USB7-	A91	N.C	B91	N.C.
A37	USB6+	B37	USB7+	A92	N.C	B92	N.C.
A38	N.C	B38	USB_4_5_OC#	A93	GPO0	B93	N.C.
A39	USB4-	B39	USB5-	A94	N.C	B94	N.C.
A40	USB4+	B40	USB5+	A95	N.C	B95	N.C
A41	GND (FIXED)	B41	GND (FIXED)	A96	N.C	B96	N.C.
A42	USB2-	B42	USB3-	A97	N.C	B97	N.C
A43	USB2+	B43	USB3+	A98	N.C	B98	DDIO_CTRLCLK_AUX+
A44	USB_2_3_OC#	B44	USB_0_1_OC#	A99	N.C	B99	DDIO_CTRLDATA_AUX-
A45	USB0-	B45	USB1-	A100	GND (FIXED)	B100	GND (FIXED)
A46	USB0+	B46	USB1+	A101	N.C	B101	N.C
A47	VCC_RTC	B47	N.C.	A102	N.C	B102	N.C
A48	N.C.	B48	N.C.	A103	N.C	B103	N.C
A49	N.C.	B49	SYS_RESET#	A104	VCC_4.75-20V	B104	VCC_4.75-20V
A50	LPC_SERIRQ	B50	CB_RESET#	A105	VCC_4.75-20V	B105	VCC_4.75-20V
A51	GND (FIXED)	B51	GND (FIXED)	A106	VCC_4.75-20V	B106	VCC_4.75-20V
A52	N.C.	B52	N.C.	A107	VCC_4.75-20V	B107	VCC_4.75-20V
A53	N.C.	B53	N.C.	A108	VCC_4.75-20V	B108	VCC_4.75-20V
A54	GPI0	B54	GPO1	A109	VCC_4.75-20V	B109	VCC_4.75-20V
A55	N.C.	B55	N.C.	A110	GND (FIXED)	B110	GND (FIXED)



## Chapter 3

# AMI BIOS Functions

The BIOS functions described in this chapter are available only if CEB94018 is connected to CPU module. For the other detailed description about how to set up basic system configuration through AMI BIOS setup utility, please refer to the CPU module user's manual.

The Advanced menu allows users to set configuration of the CPU and other system devices. You can select any of the items in the left frame of the screen to go to the sub menus:

- ▶ ACPI Settings
- ▶ NCT5104DSEC Super IO Configuration
- ▶ Hardware Monitor
- ▶ DIO Configuration
- ▶ Serial Port Console Redirection
- ▶ CPU Configuration
- ▶ IDE Configuration
- ▶ Utility Configuration

For items marked with “▶”, please press <Enter> for more options.

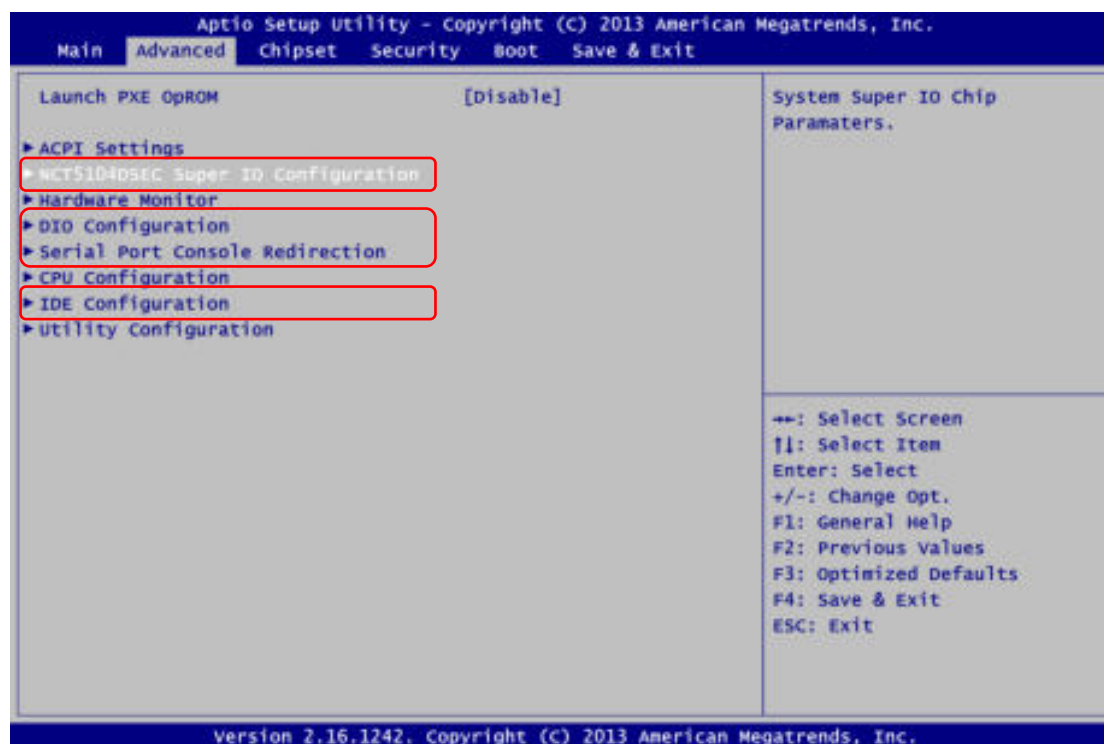

The sub menus marked with red rectangular contain functions available only if CEB94018 is connected to CPU module. The functions are COM port settings in Super IO Configuration, digital I/O settings in DIO Configuration, Serial Port Console Redirection and an extra mSATA/PCIe selection in IDE Configuration.

- **NCT5104DSEC Super IO Configuration**

You can use this screen to select options for Serial Port Configuration, and change the value of the selected option. A description of the selected item appears on the right side of the screen. For items marked with "▶", please press <Enter> for more options.

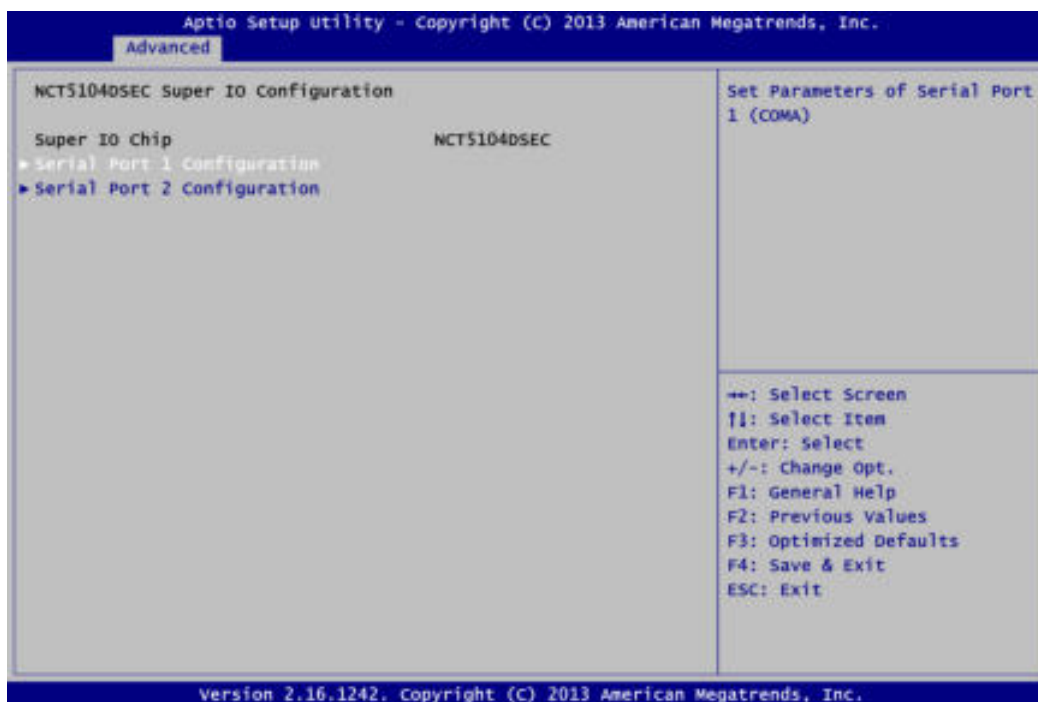

#### **Serial Port 1~2 Configuration**

Use these items to set parameters related to serial port 1~2.

- **Serial Port 1 Configuration**

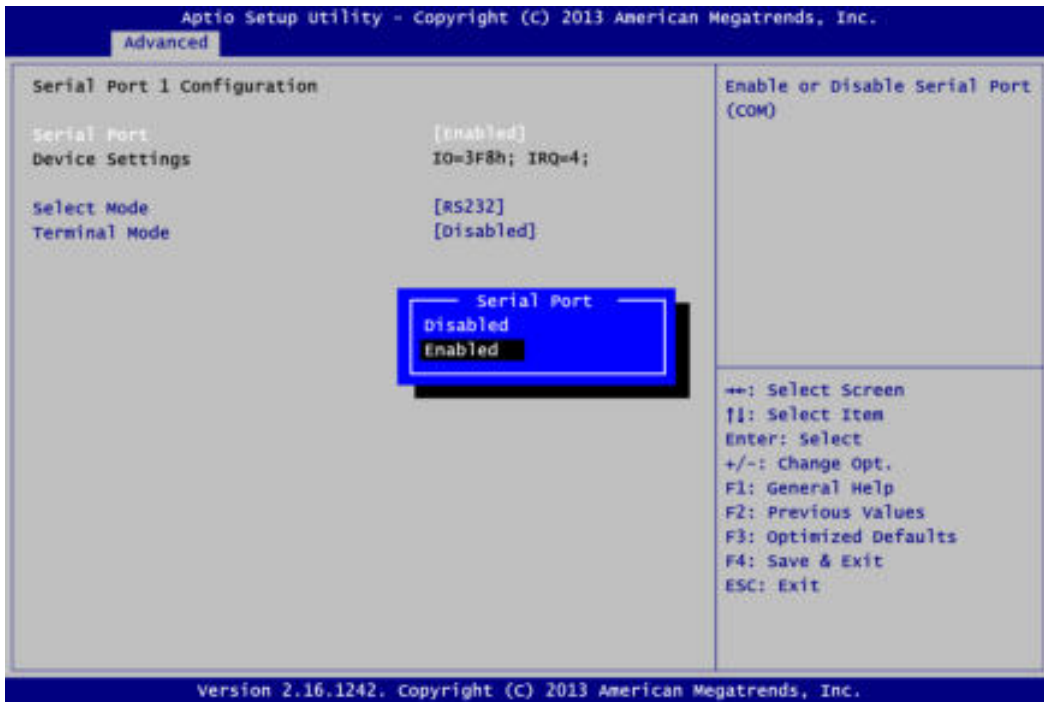

**Serial Port**

Enable or disable serial port 1. The optimal setting for base I/O address is 3F8h and for interrupt request address is IRQ4.

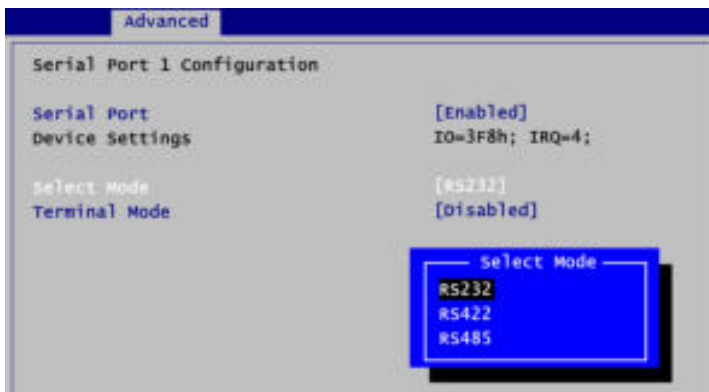

**Select Mode**

Use this item to set RS-232/422/485 communication mode.

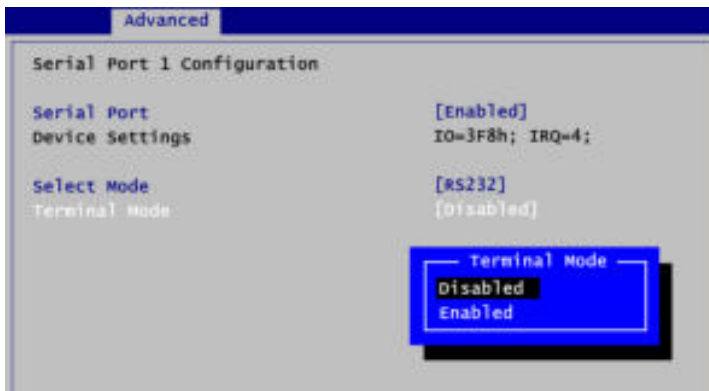

### Terminal Mode

Enable or disable terminal mode.

- **Serial Port 2 Configuration**

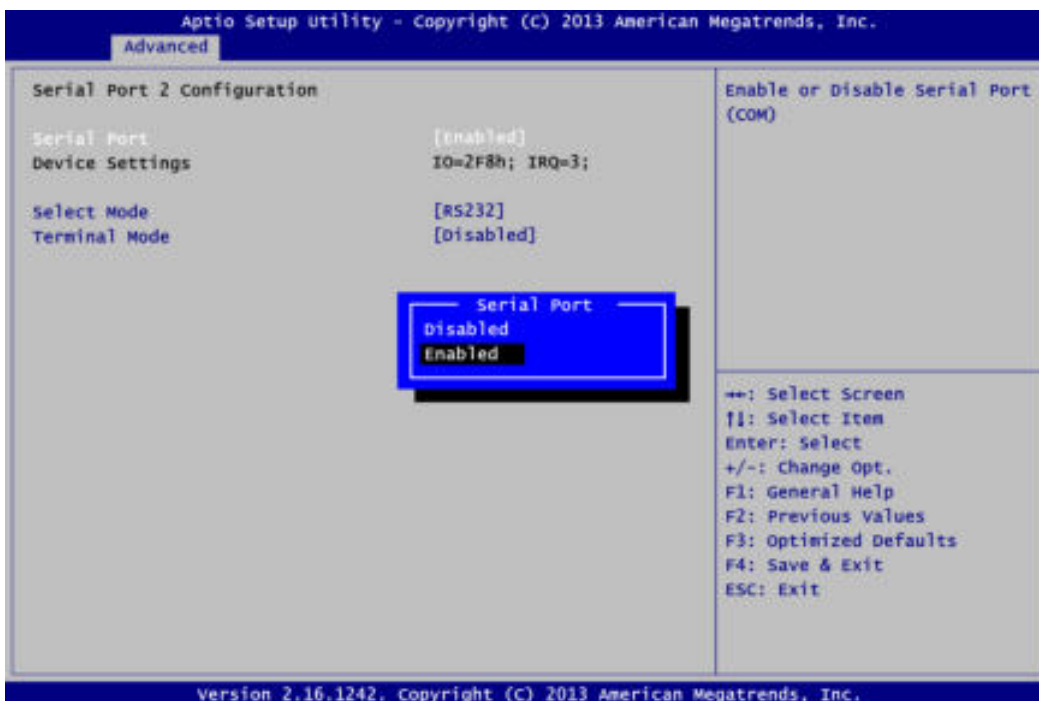

### Serial Port

Enable or disable serial port 2. The optimal setting for base I/O address is 2F8h and for interrupt request address is IRQ3.

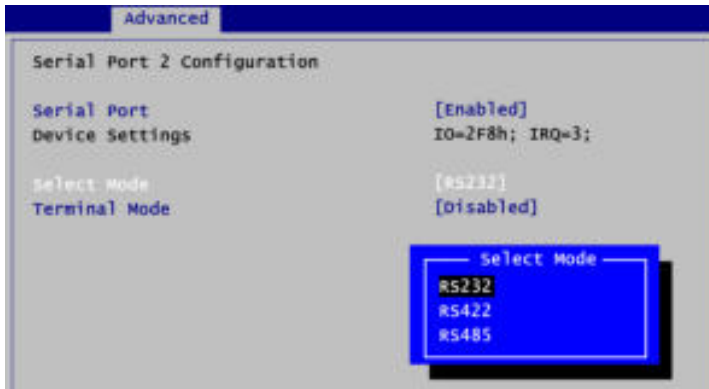

**Select Mode**

Use this item to set RS-232/422/485 communication mode.

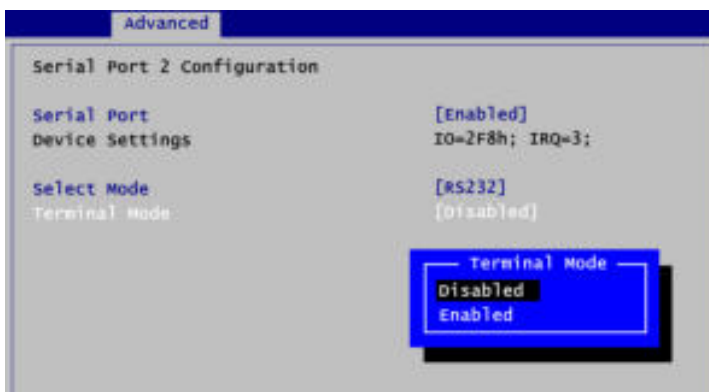

**Terminal Mode**

Enable or disable terminal mode.

- **DIO Configuration**

You can use this screen to select options for the 6-bit Digital I/O Configuration. A description of the selected item appears on the right side of the screen. For items marked with “▶”, please press <Enter> for more options.

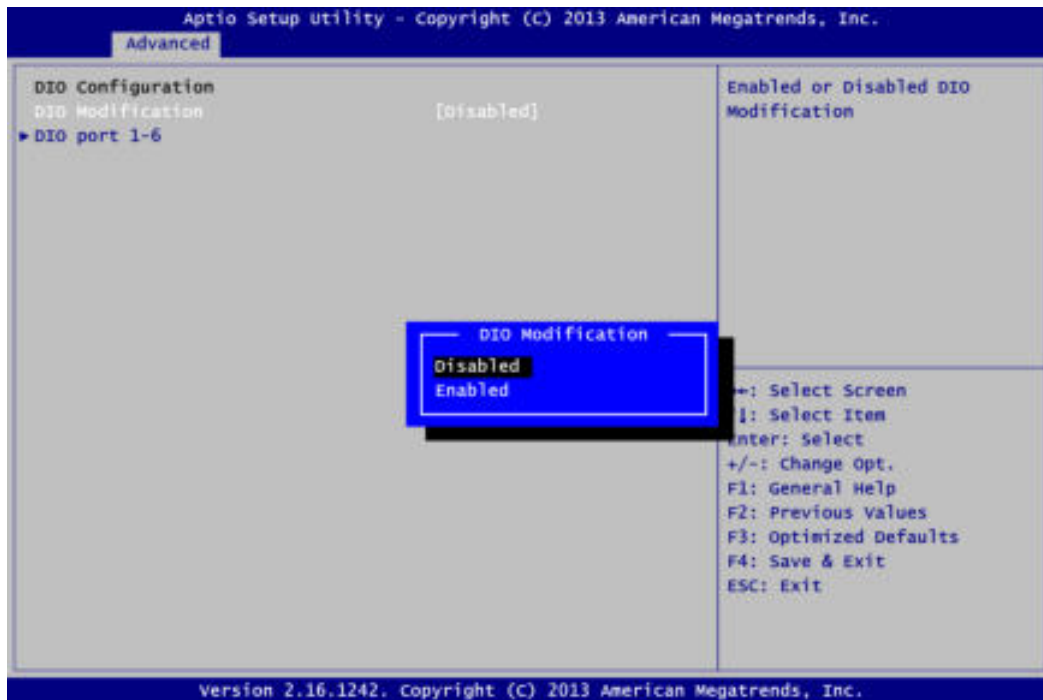

**DIO Modification**

Enable or disable digital I/O modification. If modification is disabled, the DIO status sub screen is as follows:

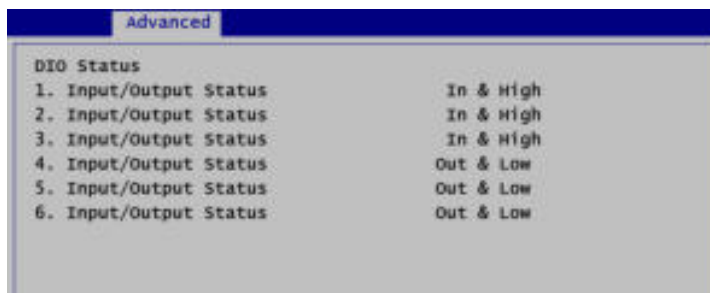

Once it is enabled, you can load manufacture default and access to the DIO status sub screen to set output or input, see image below.

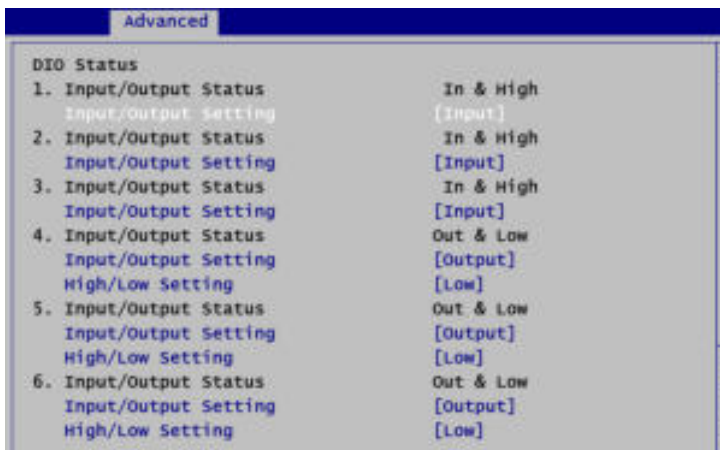
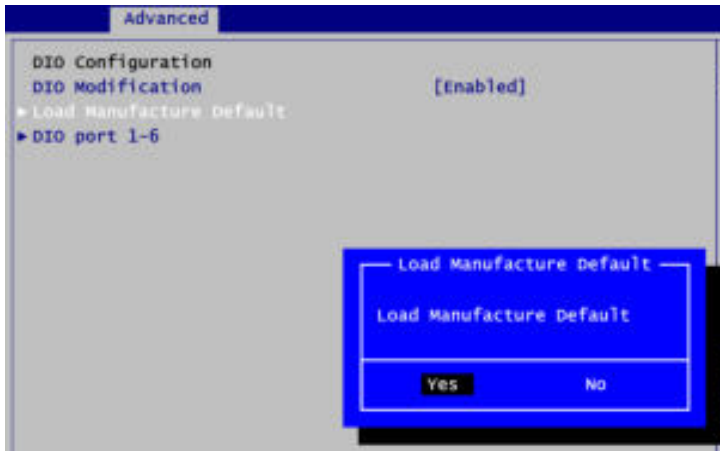

- **Serial Port Console Redirection**

You can use this screen to select options for Serial Port Console Redirection, and change the value of the selected option. A description of the selected item appears on the right side of the screen. For items marked with "►", please press <Enter> for more options.

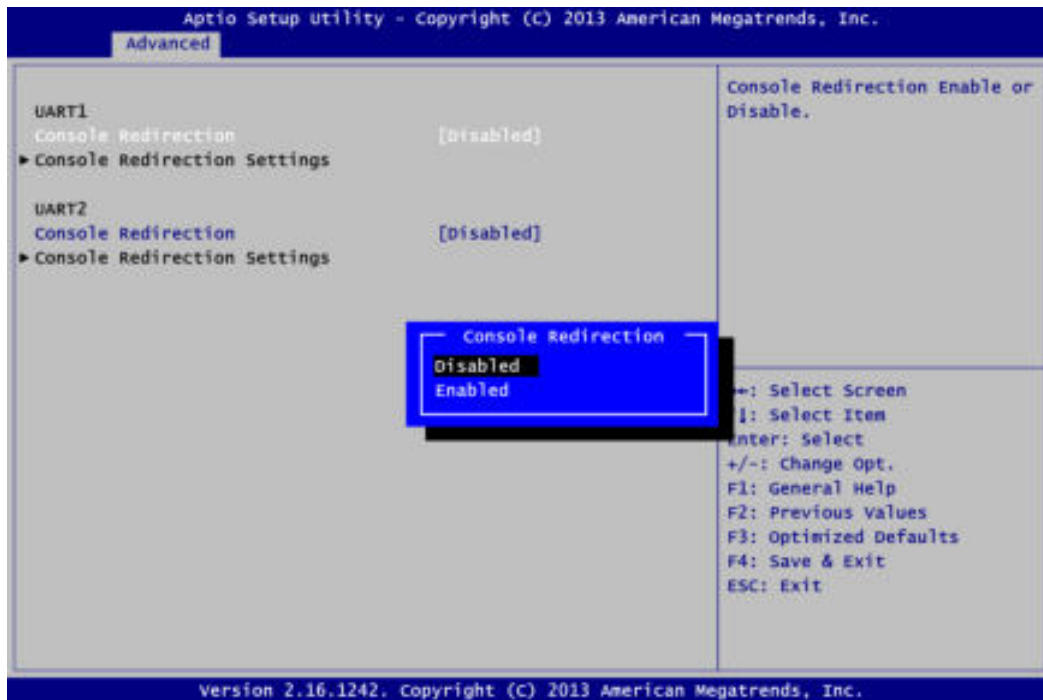

#### **UART1\UART2 Console Redirection**

Enable or disable UART1\UART2 console redirection settings.

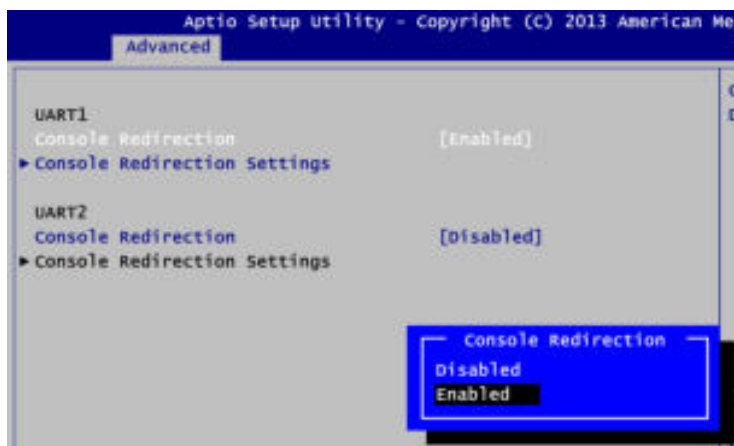



- **UART1/UART2 Console Redirection Settings**

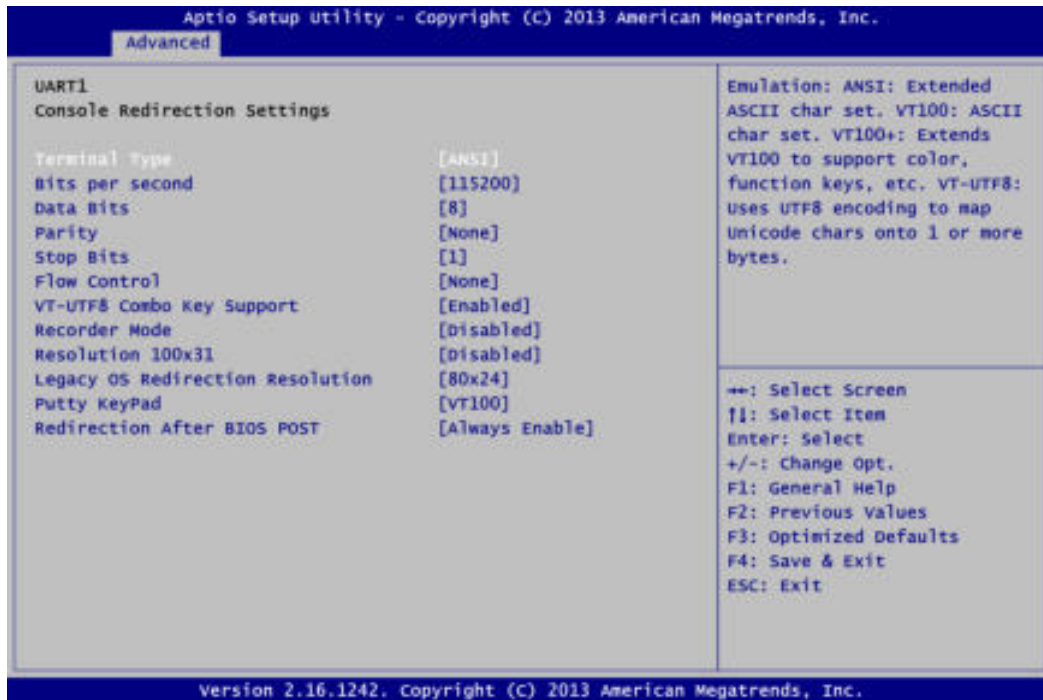

When enabled, the settings specify how the host computer and the remote computer (which the user is using) will exchange data. Both computers should have the same or compatible settings.

- **IDE Configuration**

In the IDE Configuration menu, you can see the current installed hardware in the SATA ports. During system boot up, the BIOS automatically detects the presence of SATA devices.



**SATA Mode**

The SATA mode is AHCI.

**mSATA**

Enable or disable mSATA support for PCI-Express Mini Card (see section 2.6.6). Enabling it will automatically disable mini PCIe option, and vice versa.

